



POWERED BY AMERICA SUPERIOR BY DESIGN

780 Professional Drive N, Shreveport, LA 71105
Toll Free 1-800-699-0947 Fax 318-524-2297

Parts Diagram

Differential Plate (1ea) 47J



10mm x 50mm Bolt (2ea)
MCS1050



10mm x 40mm Bolt (2ea)
MCS1040



10mm x 35mm Bolt (6ea)
MCS1035



10mm Washer (12ea)
MFW10



10mm Lock Nut (10ea)
MLN10-1.5



- 1) Place transmission in park. Place jack under center of RUV front end and lift until front wheels clear the ground. Be careful to support it properly so that it is securely supported so that A-arms and shocks can droop to full extension.
- 2) Remove front wheels and remove the front bumper.



- 3) Disconnect the bottom of the front shock from the control arm.

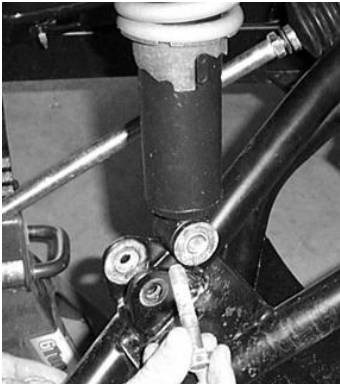

- 4) Disconnect the tie rod from the hub assembly.

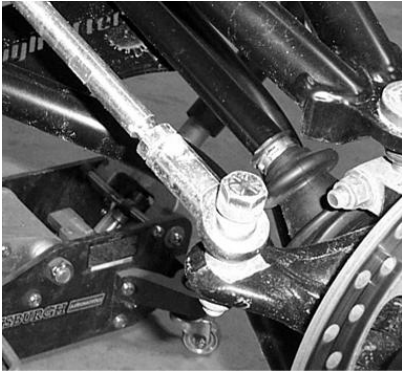

- 5) Disconnect the brake caliper from the hub assembly and secure it out of the way. **DO NOT DISCONNECT THE CALIPER!**

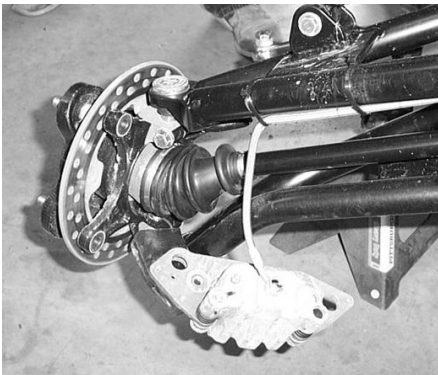

- 6) Disconnect the upper and lower arm from the hub assembly.

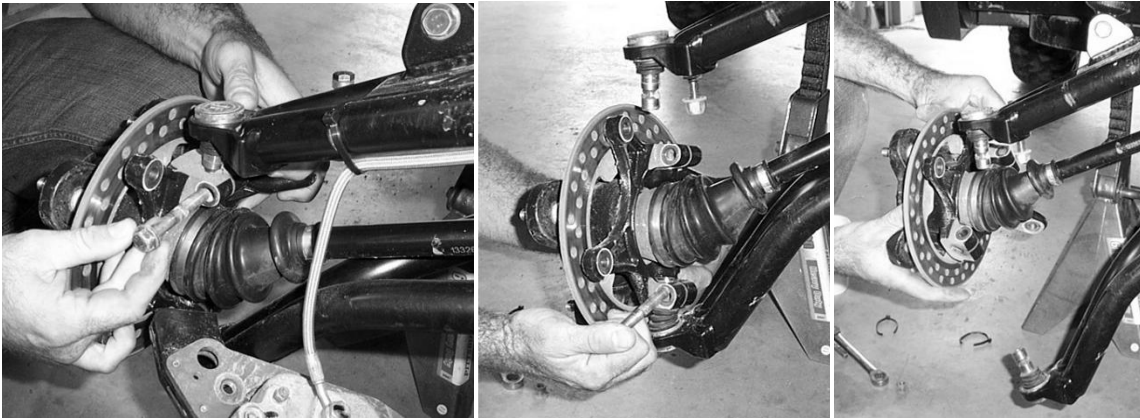

- 7) Remove the hub and axle from the differential. You will need to give it a good tug to get the axles out of the differential.

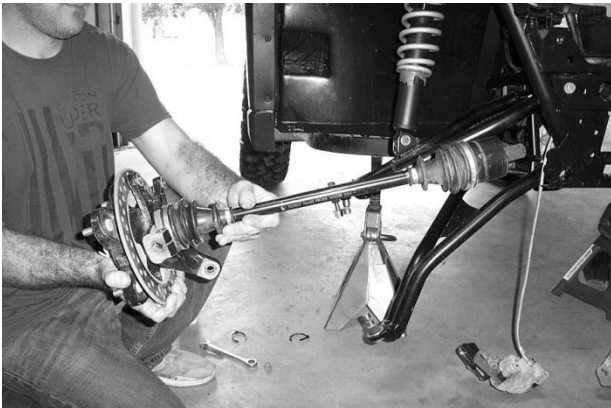

- 8) Remove the upper control arms. This will make the installation easier.

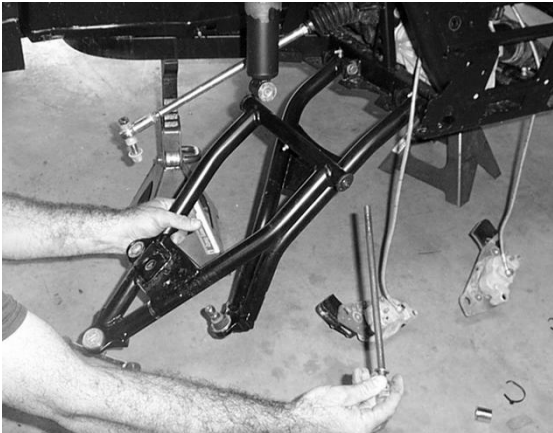

- 9) Repeat steps for opposite side.

- 10) There is a roll/spring pin that connects the differential to the drive shaft. You need to push out the roll/spring pin so that you can disconnect the differential from the drive shaft.

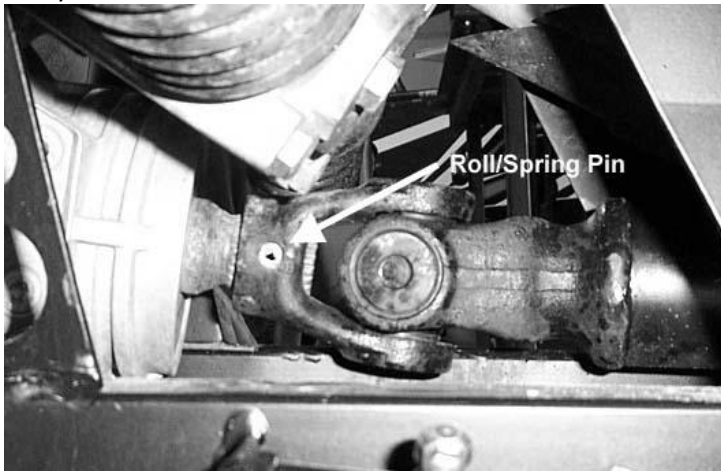

- 11) Disconnect the wires and vent line from the differential.



- 12) Remove all hardware that secures the differential to the frame.



- 13) Remove the differential from the frame.

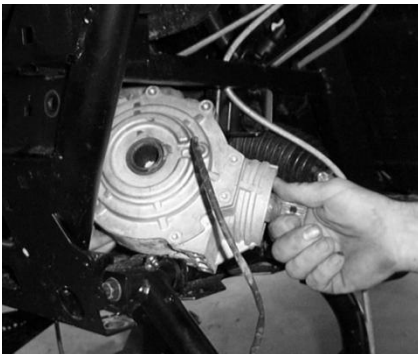

14) See the illustrated area in the photo below that need to be trimmed to allow access and fit of the differential and differential plate. The view is looking up from under the Ranger.

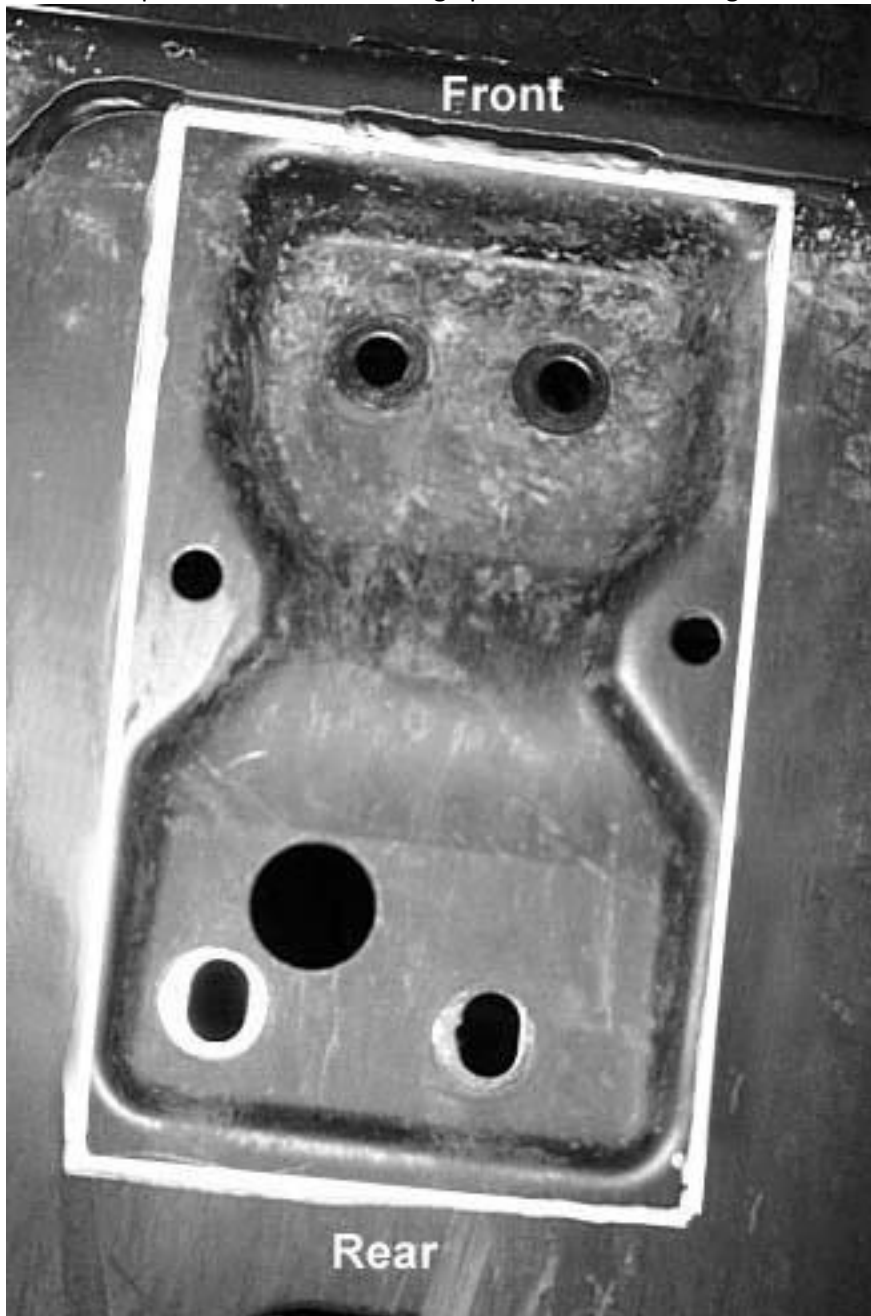

15) Mark the areas to be trimmed and trim the areas.



- 16) When you have successfully trimmed the areas use quality black paint and paint the exposed areas. This will prevent it from rusting.
- 17) Next you will need to trim the lower portion of the front bumper. You will need to do this to clearance the frame.
- 18) Review the illustrated area that needs to be trimmed in the photos below.



- 19) When you have successfully trimmed the areas use quality black paint and paint the exposed areas. This will prevent it from rusting.

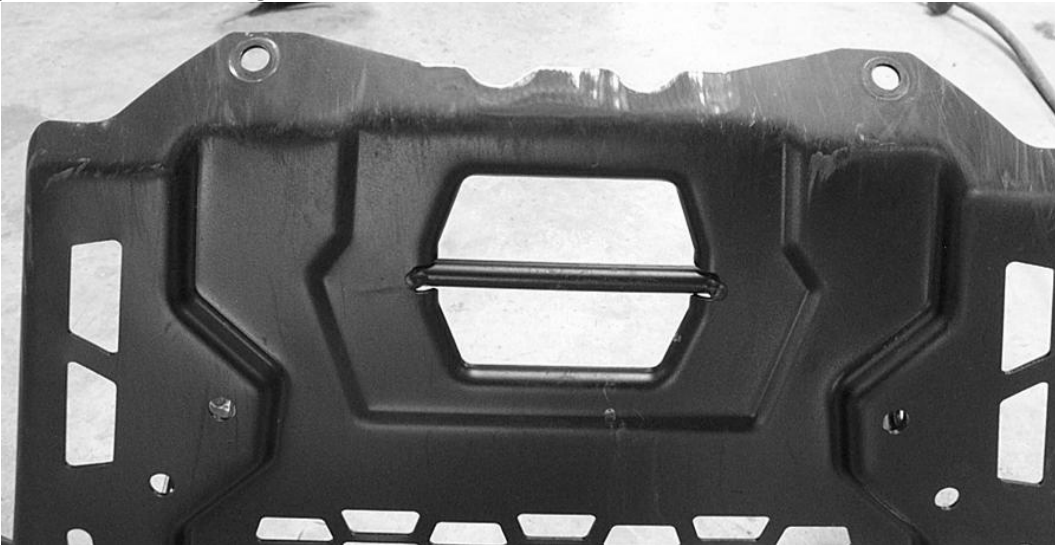

- 20) Insert the differential mounting plate into place on the frame by sliding it up from underneath. The taller differential mount goes towards the front.

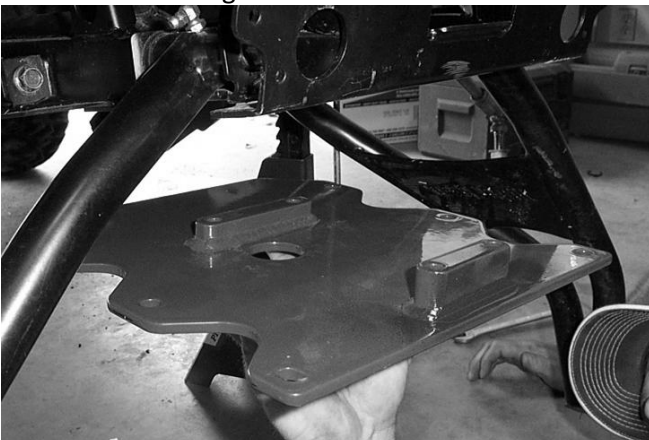

- 21) There are four holes located to the rear of the plate. You will loosely secure the place to the frame first using these holes.
- 22) Using 10mm x 35mm bolts and 10mm washers connect the plate. You will place one 10mm washer on the bolts to the rear and two 10mm washer on the next two bolts. These washers will go between the plate and frame. Loosely secure the four bolts with 10mm lock nuts. LEAVE THEM LOOSE!

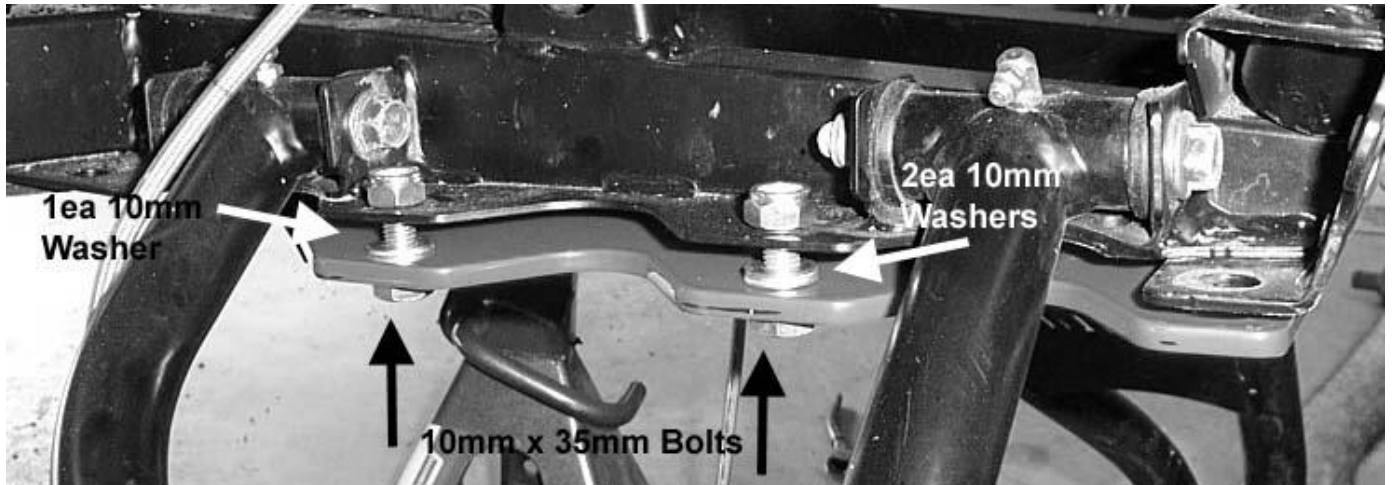

- 23) Next insert the Polaris RZR 1000 differential into the frame.

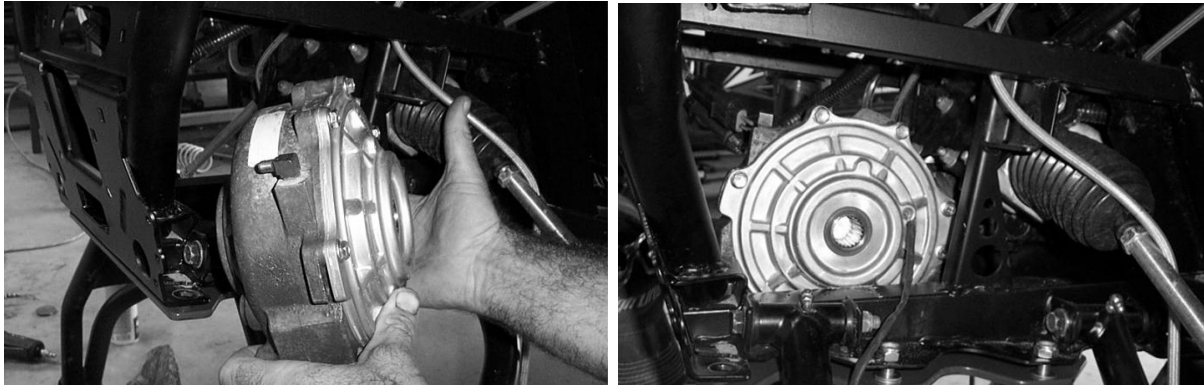

- 24) Connect it to the drive shaft, aligning the roll pin holes in the drive shaft and shaft on differential.
NOTE: It is easier to install the roll pin when the differential is bolted to the plate.

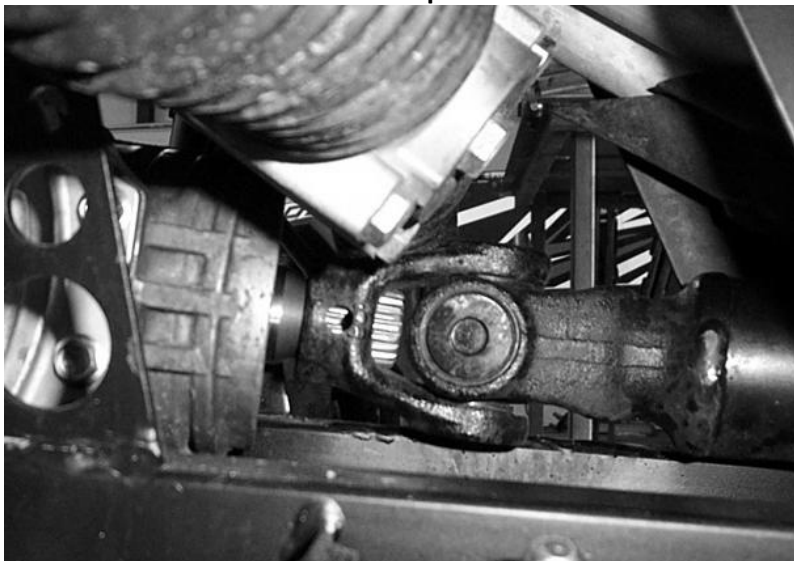

25) Connect the differential to the mounts on the plate. You will use two 10mm x 40mm bolts on the short mount and 10mm x 50mm bolt on the taller mount. **Make sure to use the Red thread locker provided on these bolts.**



26) Push the bolts up from under the plate. Place a 10mm washer in the bolts before you insert them into the holes. Once you have done this tighten the bolts. The view is from under the Ranger

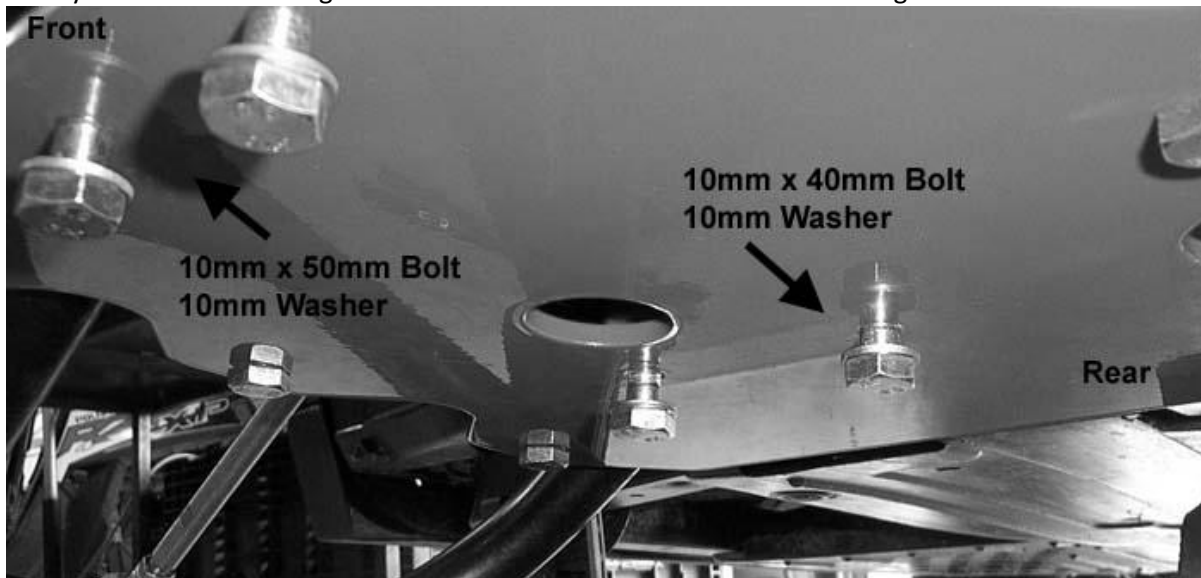

27) Insert the roll pin into the driveshaft.



28) Tightly fasten all remaining hardware on the plate.

29) Where the lower control arms connect to the frame you will need to create a clearance for the CV boots.

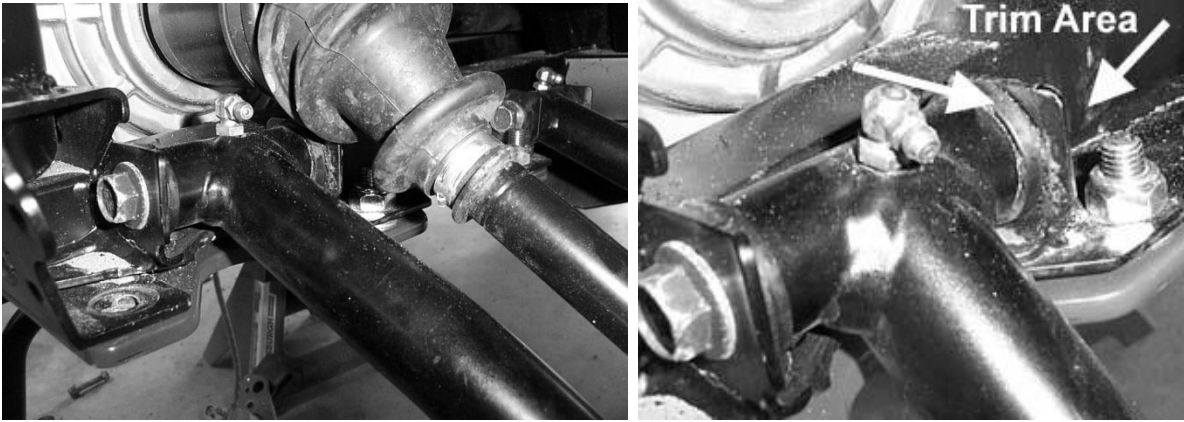

30) You will need to trim the tab on the control arm mounting point. Do this for both sides.

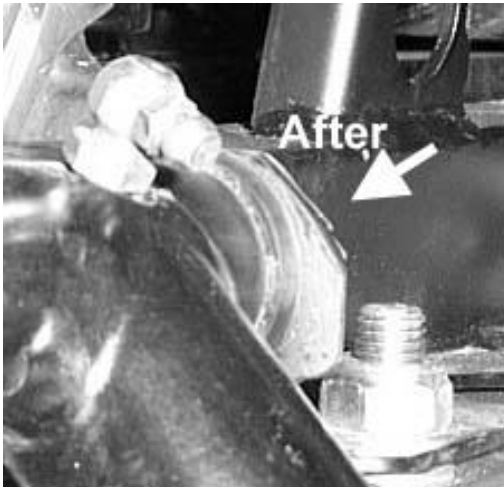

31) Next reconnect the upper control arms to the frame.

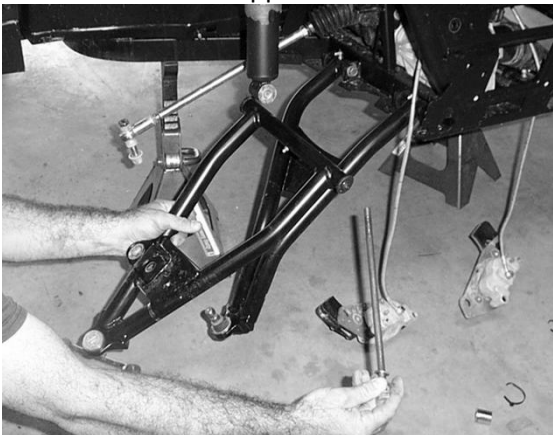

32) Reconnect the axles, hub assemblies and calipers. Use factory hardware.

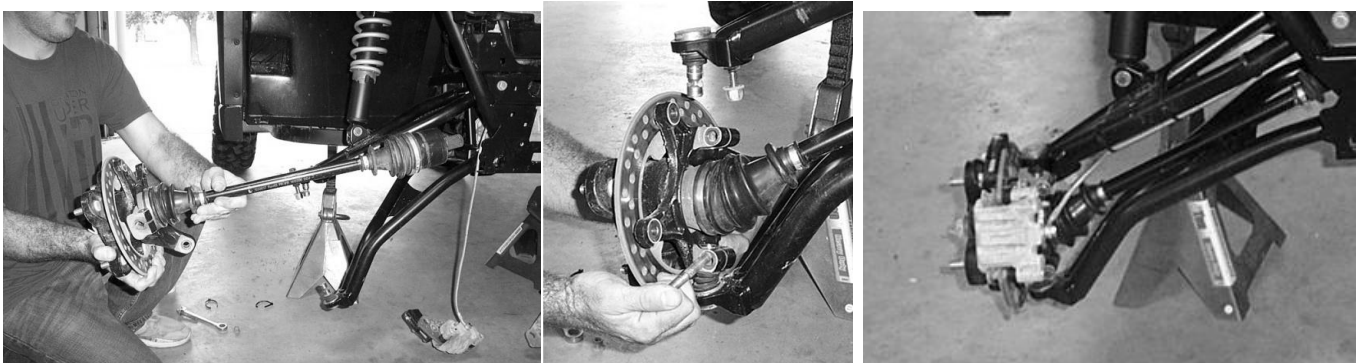

33) Now reconnect the front bumper to the frame.



34) Where the bumper connects to differential plate, use the 10mm x 35mm bolts, 10mm flat washers and 10mm lock nuts.

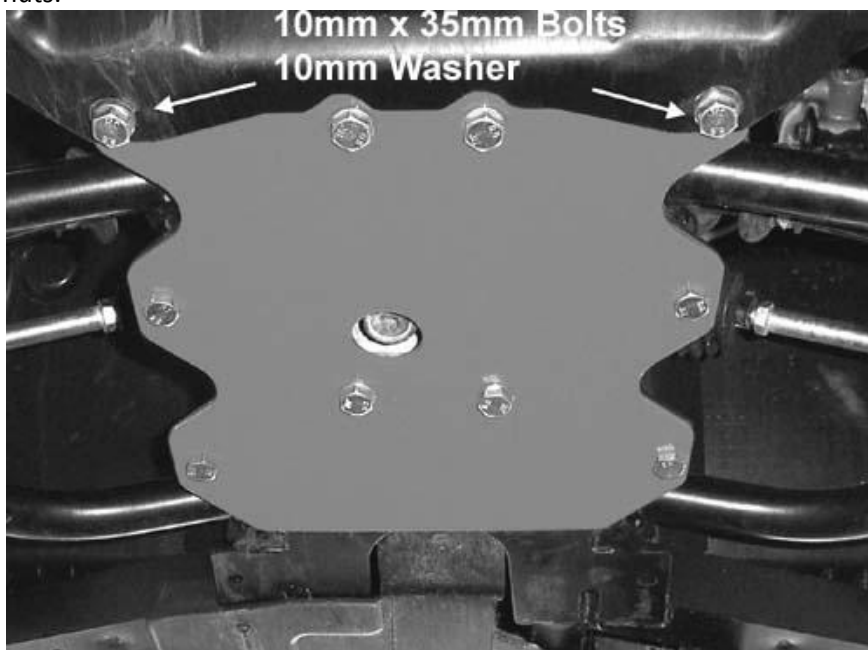

35) Make sure that the differential is filled with fluid.

36) Place tires and wheels back on the RUV. Torque lugs to factory specifications.