



780 Professional Drive N. Shreveport, LA 71105 Phone (318)-524-2270 Fax (318)-524-2297  
www.highlifter.com

## PLK335/500

### Read before Installation

This product is designed for use on ATVs and/or RUVs to increase ground clearance and fender clearance. Purchasers should be aware that use of this product may increase the frequency of required maintenance, part wear, and will raise the center of gravity on your ATV and/or RUV, increasing risk of roll-over, injury and death on all types of terrain. It is your responsibility to always inform other operators and passengers of this vehicle about the added risks.

High Lifter Products, products are designed to best fit users ATV/RUV under stock conditions. Adding, modifying, or fabricating any OEM or aftermarket parts will void warranty. High Lifter Products, products could interfere with other aftermarket accessories. If the user has aftermarket products on machine, contact High Lifter Products to verify that they will work together. Adding aftermarket suspension components and/or more aggressive tires can cause breakage of other OEM driveline components such as differentials, axles or drive shafts.

We recommend that wider tires and/or wheel spacers be used to achieve a wider stance and to improve stability of the ATV and/or RUV. Riders should be advised that the handling characteristics of a taller ATV and/or RUV are different and require extra care when riding, particularly on side hills or off-camber situations. If you further raise the center of gravity by adding taller tires, heavy loads to racks or seats, or by any other means, the ATV and/or RUV must be operated with even more care, at slower speeds and on relatively flat ground. All turns should be done at a slow speed, even on level ground.

Operation of an ATV and/or RUV with or without modified suspension components, while or shortly after consuming alcohol or drugs, subjects the rider to the risk of serious bodily harm or possible death. This risk is compounded if the rider does not wear an approved helmet and other safety gear. High Lifter urges that all approved safety gear be worn when riding an ATV and/or RUV as a driver or passenger.

By purchasing and installing High Lifter Products, products, user agrees that should damages occur, High Lifter Products will not be held responsible for loss of time, use, labor fees, replacement parts, or freight charges. High Lifter Products will not be held responsible for any direct, indirect, incidental, special, or consequential damages that result from any product purchased from High Lifter Products. The total liability of seller to user for all damages, losses, and causes of action, shall not exceed the total purchase price paid for the product that gives rise to the claim.

### Dealers and other Installers

You are responsible for informing your customer and end user of the information contained above and the increased potential hazards of operating an ATV and/or RUV equipped with modified suspension components. If you install any suspension modifying components, it is your responsibility to also install the warning label prominently in view of the driver and in prominent view of the driver and passenger on RUVs and multi-passenger ATVs. They should also be instructed to notify anyone operating the vehicle, as well as any passengers, that said vehicle is modified.

As discussed above, it is critically important that they be instructed in the need for slower speed operation, regardless of terrain, after this lift kit is installed.

This lift kit contains the following parts:

3/8"x 2 1/4" Bolts	4
3/8" Nuts	4
Flat Washers	6
Lift Brackets	12
Pages of Diagrams	3
Pages of Instructions	2

**WARNING: The McPherson struts on the front of this ATV are preloaded and are under extreme pressure. A spring compressor is required for the installation. Most local auto parts stores carry spring compressors for around \$25 for a very basic model. If you do not have experience working with this type of tool, we strongly recommend that an authorized**

**factory dealer install this lift kit. This job will be much easier if you will remove your front plastic, which will allow you to pull the strut straight out from the top.**

## **Front Lift**

- 1) Place jack under center of ATV front end and lift until front wheels clear the ground. Be careful to support ATV properly so that it is secure, but so that the A-arms and shocks can drop about 2".

**Warning:** DO NOT let the A-arms drop to full extension. If you allow the A-arms to drop to full extension, the axle will possibly come out of the hub. If this happens, you will spend two more hours fixing this. For those of you that got ahead of yourself and are already facing this dilemma, don't panic. Get a Polaris repair manual or have your local Polaris dealer correct this problem.

- 2) Remove front wheels and boot guards.
- 3) Using a spring compressor, compress the front struts. Take the top nut off, loosen the bottom two bolts and slide the strut out. **Tip:** (When sliding the strut out, be sure it is completely collapsed. This will make it easier to get out.) **For the Novice:** When you first start to pull the strut out it will want to extend. Once several inches of the bottom shaft are exposed, you can hold the bottom and push the top back down. You may have to do this several times in order to get the strut out of the socket.
- 4) Drop bracket "A" into the bottom of the strut socket and place bracket "B" on the top lip.
- 5) Place the factory washer over bracket "B" and slide the strut back into the socket. You may need to use a screwdriver between the springs to push the bottom of the strut down into the socket. (Note: Make sure the bottom of the strut is resting on the top of bracket "A". You can feel bracket "A" from underneath, to verify it's touching the bottom of the strut. DO NOT put your finger up into the hole.)
- 6) Tighten the bottom two bolts and reinstall the top nut on the top of the strut. (Be sure to reattach the brake line to the top bolt if you took it off.)
- 7) After all bolts have been tightened, loosen and remove the spring compressor.
- 8) Repeat this process on the other side.
- 9) Install the wheels, torque wheel lug nuts to manufacturer's specifications, lower and remove jack. Check for clearance problems or misalignment.

## **Rear Lift**

- 1) Place jack under ATV at the rear of the bottom skid plate and lift until the weight is off the suspension. Be careful to secure the ATV properly so as not to fall off the jack.
- 2) Remove both rear shocks and wheels. (The lift can be installed with the bottom of the left shock on, but this can make it more difficult to align the lift bracket.)
- 3) After removing the shocks, jack the ATV up an additional 1"-2".
- 4) Remove the two spacers to the torsion bar.
- 5) Insert one of the new bolts through bracket "C", the top shock mount and the bracket "D" (spacer). (See diagram). (Place 2 washers on one side of the shock and 1 on the other.)  
Note: It is generally easier to install bracket "C" and the washers on the top of the shock before attaching the bracket to the shock mount on the right side because of the exhaust system.
- 6) Install the bottom of bracket "F" on the outside bolt of bracket "C" (bracket on top of shock), and attach the top of bracket "F" to the rear utility rack mounting bracket. (See Diagram and \*Note).
- 7) Install bracket "E" on the torsion bar and axle using the factory bolts. This bracket is just like the factory bracket except it is slightly larger.

- 8) Repeat this process on the other side.
- 9) Tighten all bolts to manufacturer's torque specifications. Install the wheels, torque wheel lug nuts to manufacturer's specifications, lower and remove jack. Check for clearance problems or misalignment.

### Parts List

**Bracket A-2**

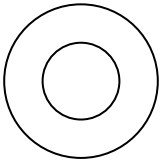

**Bracket B-2**

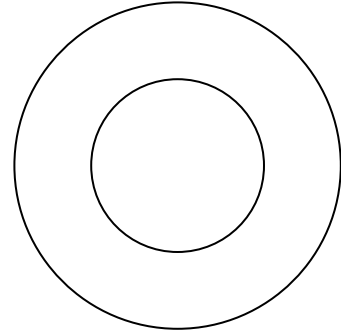

**Bracket C-2**

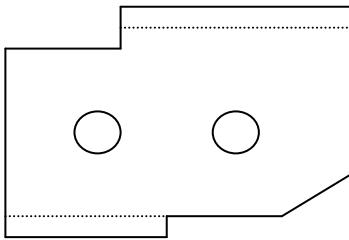

**Bracket D-2**



**Bracket E-2**

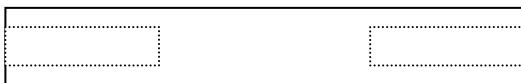

**Bracket F-2**

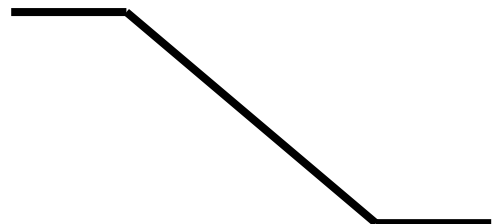

## Rear Installation

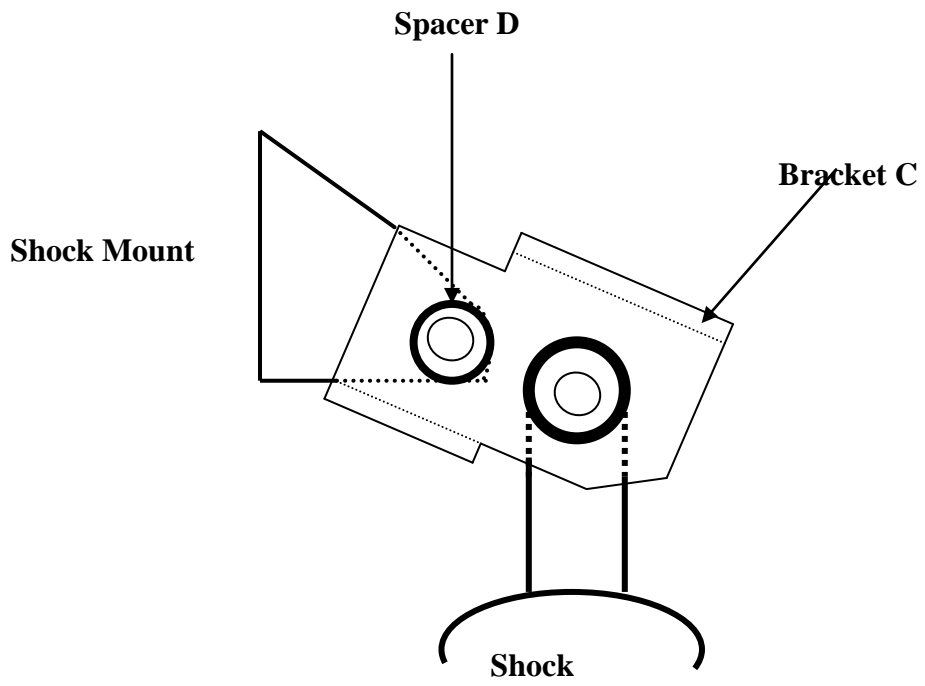
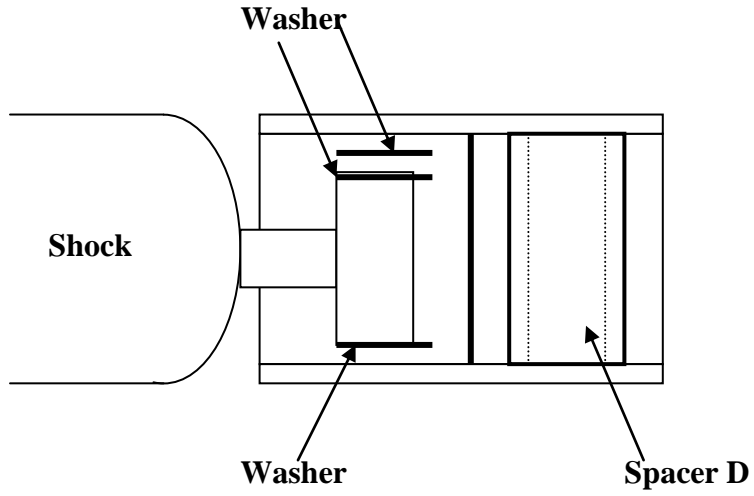

## Bracket F Installation

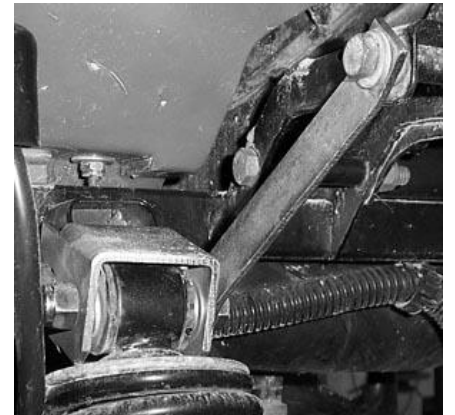
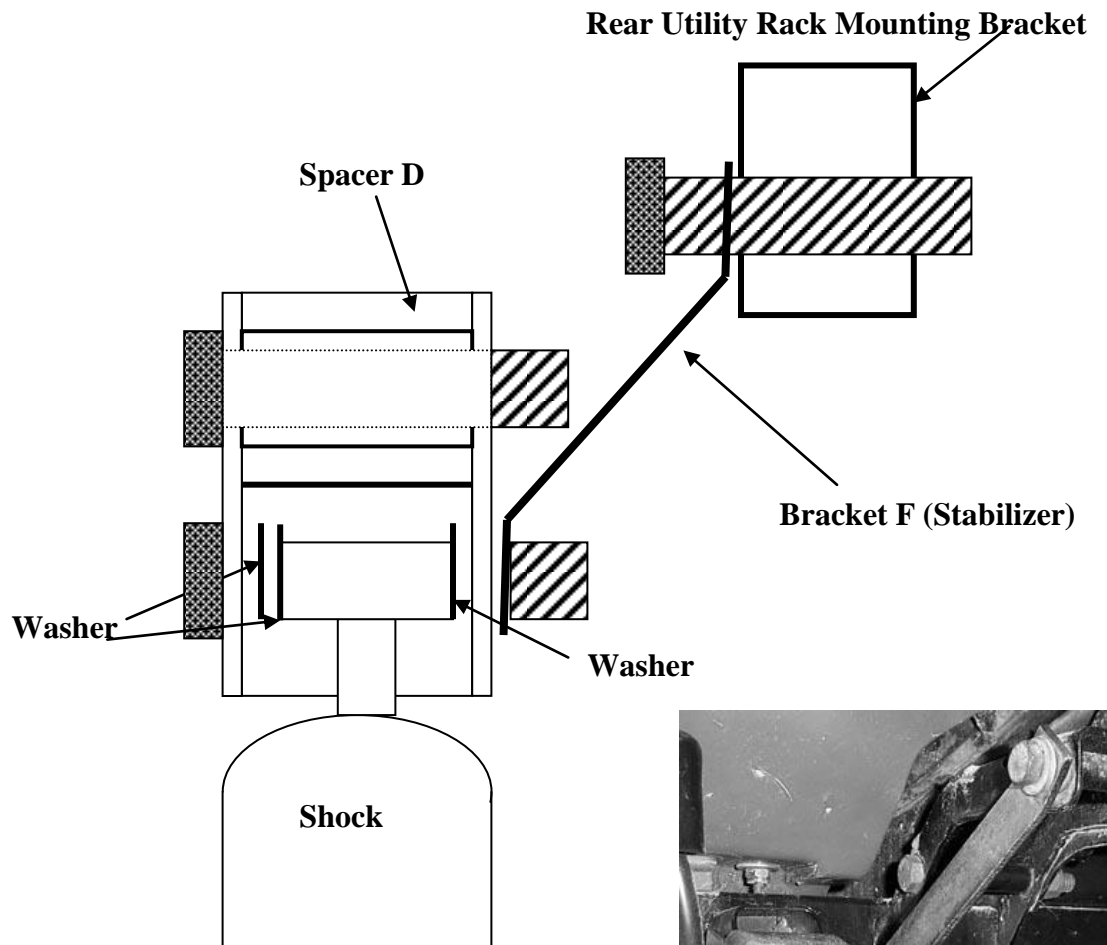

### **\*NOTE:**

Lift kit Bracket is installed in an approximately horizontal position. Stabilizer prevents end with shock bolt from rotating up and down.

For those of you with CV joints this bracket is not needed, but if you are able to install it, go ahead. The purpose of this bracket is to keep U-Joints from making an absolute right angle, by not allowing the rear a-arms to fully extend.

**Thank You**

**For choosing**





### **High Lifter Lifetime Warranty**

From the beginning, High Lifter has engineered and manufactured some of the toughest, most durable products on the market. That's why this product comes with a Lifetime Warranty. It's our promise that High Lifter will never let you down.

- The **Lifetime Warranty** covers products sold to the original purchaser only and is not transferable. The term of the warranty is for the lifetime of the vehicle in question.
- Normal wear and tear items and finishes, such as, but not limited to: Heim joints, tie rod ends, ball joints, bearings, seals, bushings, bushing sleeves, zinc plating , powder coating, or chipping and discoloration of any finish is not covered.
- High Lifter will ship the replacement product after the returned product has been inspected by High Lifter staff.
- The warranty shall not include claims for damages, installation time or labor charges, economic losses, inconvenience, transportation, towing, down time, direct or indirect or consequential damages or delay resulting from any defect.
- The warranty does not apply to products that have been improperly applied or improperly installed.

### **Making a warranty claim**

1. All claims must be accompanied by the part and the original sales receipt or other acceptable proof of purchase from the original owner.
2. All warranties must be accompanied with a Return Merchandise Authorization (RMA) number. (Contact High Lifter at 318-524-2270 or 800-699-0947 for an RMA number)
3. When shipping the damaged product:
  - a. Write the RMA number on the outside of the box.
  - b. Also include the RMA number, proof of purchase and any notes inside the box.
  - c. Please keep your tracking number and shipment information.
4. The customer is responsible for shipping the product to High Lifter--return shipping within the lower 48 states will be paid by High Lifter products. With all warranty claims, only standard shipping services apply.
5. High Lifter will process your order within 24 business hours of receiving the returned item.
6. **Ship to:** High Lifter Products, 780 Professional Drive North, Shreveport, Louisiana 71105