

EX-RAY **VOLTAGE**

**Digital Speedometer Panel With Voltage
Meter for Golf Carts, NEV, Conversions**



USER'S MANUAL - GEN3

SPEED | DISTANCE | TEMP | CLOCK | BATT VOLTAGE



*“An Aftermarket solution
for Electric Vehicles used
on-road or off-road”*



**MADE IN
THE USA**

Short Cuts





























- Normal Mode:**
-  OR  = Activate backlight manually
 -  OR  = Switch between screens in normal mode
 -  OR  = Start or stop the stop watch
- Data Setting Mode:**
-  +  +  = Enter data setting mode
 -  = Switch between screens in data setting mode
 -  = Scroll through current data setting
 -  = Move to next digit of current data setting
- Data Reset:**
-  +  + 3sec. = Reset single-ride data
- Adjustable Trip Distance Edit:**
-  + 3sec. = Enter/exit adjustable trip distance edit mode
 -  OR  = Scroll distance value
- Rally Mode:**
-  + 3sec. = Enter/exit rally mode
 -  OR  = Scroll distance value
- Lap Timer Mode:**
-  +  + 3sec. = Enter/exit lap timer mode
 -  +  + 3sec. = Clear lap timer data
 -  = Start/stop lap timer
 -  = Signal new lap
 -  = Enter/exit lap data review mode
 -  OR  = Scroll through lap information

Table Of Contents

2	Short Cuts (Quick Set up guide)
3	Table Of Contents
4	Welcome to EDT Ilc
	> Enter Dealer and warranty purchase information
5	Precautions
6	Specifications
8	Overview
11	Installation
	12 Parts Breakdown
	13 Universal Bracket - Steering Column Mount
	15 CNC Bracket - Steering Column Mount
	18 Temp Sensor Mount
	22 General Speed 10mm BOLT Sensor Installation
	25-Short hub Mag, 28-31 Short-long axle,
	32-Jakes Disc Brake, 34-ClubCar Lift
	36 Speed TAB Sensor ClubCar XRT Installation
	38 Power Cable Installation
	39 Steering Column Wire Protector
40	Wheel Size Calculator
43	Data Setting Mode
	> MPH/KPH, Temp limit Warnings, Date & Time,
	DC Voltage warnings, Maintenance Schedules
52	Normal Screen Modes
	> Screen 1-2-3, Sleep Mode, Reset data screens
54	EX-RAY Features
	> Explanations of all screen data, settings, functions
63	Troubleshooting / FAQ's
65	Inch to Metric Tire Size Conversion Chart
66	Glossary
68	EX-RAY Model Numbers, Kits, Replacement Parts
70	EX-RAY USER Setup notes and battery change dates
72	Warranty Statement

Welcome to EDT-Exray

Thank you for purchasing an EDT.Ilc Product:

The EX-RAY™ is Digital Speedometer Display, the EX-RAY™ product line provides valuable information about your vehicle for your gas or electric golf car or modified buggy, Neighborhood Electric vehicle (NEV), or Small Task Oriented Vehicle.

Please read this manual carefully before installing your EX-RAY™ Display. Note: This Manual intended as guide to proper installation but cannot predict every possible application. Some modifications may be required.

EX-RAY™ is a trademark of the Energy Design Tek LLC Company Oregon USA

Please Record Important Information:

For customer support, record the following information:

PURCHASE DATE: _____

DEALER: _____

DEALER PHONE: _____

EX-RAY MODEL (ON BOX): _____

Keep this manual, sales receipt, and original box for future use. Serial Number TAG and WARRANTY last pages.

SAVE THESE INSTRUCTIONS

Precautions

WARNING:

When using the EX-RAY™ follow basic precautions, including the following:

- Read all instructions before using the EX-RAY™
- When installing the DC Motor temperature Sensor, be careful removing the bolt and not to damage the motors internal field coil. EDT Ilc is not responsible for damage done during this process.
- Use EX-RAY™ only for its intended purpose.
- To reduce risk or injury, do not disassemble EX-RAY™ or its accessories.
- EX-RAY™ can be used in the rain but should not be used under water.
- Do not leave the main unit in direct sunlight when not being used.
- Check magnetic sensor gap and magnet mounting periodically.
- Do not bend, twist, kink, or otherwise abuse the sensor cables. A damaged cable may produce incorrect readings.
- When installing EX-RAY™, turn the vehicle power off (or ignition switch off); the wires carry power from the vehicles battery.
- Avoid contact with gasoline, de-greasers or other chemical cleaners as they may damage the EX-RAY™.
- Do not exceed 60VDC at any time as this may damage the EX-RAY™.

Specifications

FUNCTION	ICON	UNITS	RANGE
Current Speed	SPD	KM/H or M/H	4 - 299.9
Average Speed	AVG SPD	KM/H or M/H	4 - 299.9
Maximum Speed	MAX SPD	KM/H or M/H	4 - 299.9
(Trip) Distance	DST	KM or M	0.00 - 299999
Odometer	ODO	KM or M	0.00 - 299999
Voltage	V	VAC/VDC	1.6-52.6
Minimum Voltage	MIN V	VAC/VDC	1.6-52.6
Maximum Voltage	MAX V	VAC/VDC	1.6-52.6
Hourmeter / Clock	⌚	H:M:S	12h or 24h
Ride Time	RT	H:M:S	0:0:0 - 9999:59
Stop Watch	TT	H:M:S	0:0:0 - 9999:59
Accum. Ride Time	ART	H:M:S	0:0:0 - 9999:59
Air Temperature	AIR	°C or °F	0 - 999°
Engine Temperature	🔥	°C or °F	0 - 999°
Max Engine Temp	MAX 🔥	°C or °F	0 - 999°
Oil Reminder	🛢️	KM/H or M/H	0.0 - 9999
Care Reminder	🔧	KM/H or M/H	0.0 - 9999
Low Battery	🔋	3V	~ 1 year life
Tire Size		mm	0 - 3999 mm

Specifications

PHYSICAL FEATURE	DESCRIPTION
Speed/Distance Sensor	Non-contact Magnetic Sensor
Temperature Sensors	External Ambient and Engine Thermistor Sensors
Voltage Sensor	Red/Black Power Wire
Remote Thumb Switch	Optional, Mirrors Main Buttons
Backlight	5 White LED Group
Product Dimensions	106.93x59.46x23.7mm WxHxD (4.21x2.34x0.93")
Screen Dimensions	78.75 x 28.6mm (3.1 x 1.13")
Product Weight	3.9 oz. (110 grams) (0.24 lbs.)
Wheel Circumference	0 to 3999 mm
Operation Temperature	0°C to 60°C (32°F to 140°F)
Storage Temperature	-20°C to 80°C (-4°F to 176°F)
Battery	3V CR2032 (About 1 Year life)
External Power Input	9.0-400 VAC (No Polarity) 9.0-55.0 VDC (No Polarity)
Critical Environment	Amber/Red LED Alert System

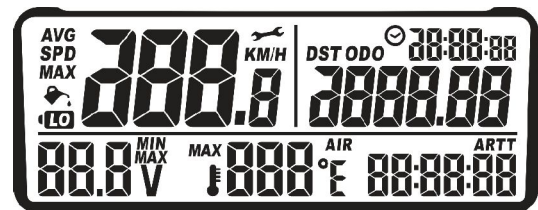

Overview

EX-RAY™ Digital Speedometer:

Main Display:

- The display panel includes 3-user buttons, 2-warning LED's, and the LCD screen.

LED's:

- Amber LED: Lights for temperature warning alert (SOLID), Battery LOW Warning (FLASH).
- Red LED: Lights for over-temperature alert (SOLID) and Battery LOW DANGER (FLASH).

Remote Switch (optional) uses 4th CONNECTOR:

- Optional remote switch (special order only) is used to access the display buttons remotely. Contact EDT LLC for more information. **If not using remote, LEAVE 4th CONNECTOR DISCONNECTED!**

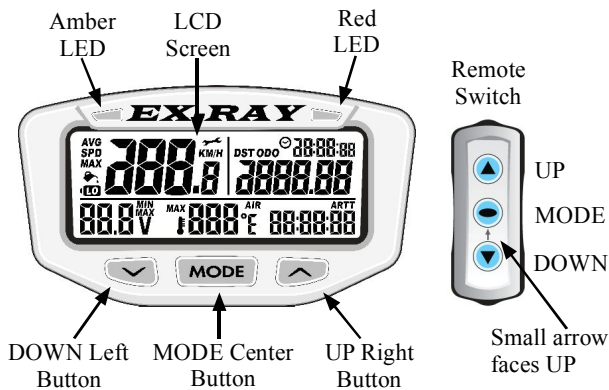

8

Parts and Features

Display Backlight:

EX-RAY is equipped with a backlight for easy viewing during night time operation.

Using External 12V Power:

- Display Backlight will light up with all five backlight LED's
- EX-RAY will remain lit as long as it senses wheel movement. **After 10-20 minute of inactivity, EX-RAY shuts off the backlight.** Press any button, roll the wheels, turn on key switch (electric golf cars) or start the engine (gas golf cars) and EX-RAY will light up again
- Amber and Red LED's enabled (Shift or temperature)

Using Internal Batteries Only:

- EX-RAY will only stay lit for 3 seconds
- EX-RAY backlight will light up with 10% power to conserve the internal battery power.
- If the LO symbol is present, the backlight will not turn on. The LO symbol appears when battery voltage drops below 2.45V
- If ambient temperature is cold (below -5°C, 23°F) the backlight will not turn on.



TO ACTIVATE BACKLIGHT MANUALLY PRESS



9

Parts and Features

Reset Button:

Use the Reset Button to erase data from the current ride including clock and trip distance. Reset may also be required when ever UNPLUGGING A SENSOR. (Forced computer to re-read the sensor)

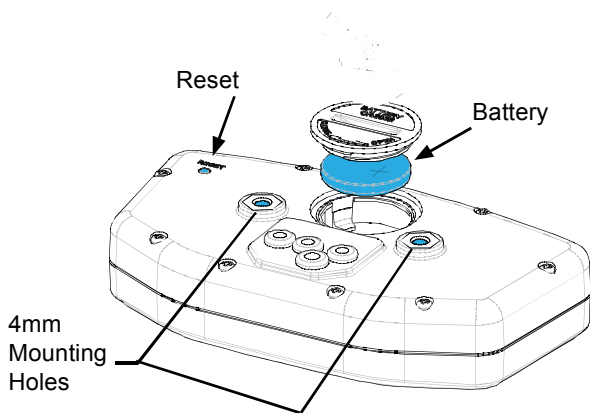

Internal Battery:

- EX-RAY has an internal non-rechargeable Lithium watch type battery (#CR2032). The computer can be run from the internal battery without external connection to vehicle power source. Use a high QUALITY battery to last longer!
- To change the battery, unscrew the battery cap on the back of the computer with a coin. Make sure the POSITIVE SIDE of the battery is FACING UP when replaced.
- **REPLACE WITH BATTERY MODEL NUMBER CR2032**

Installation

Unpacking the Display:

Carefully remove the display from the packaging and verify all the parts are included for your application.

Carefully remove the EX-RAY cardboard TRAY from the box. Be careful not to damage the rear mounted connectors. Your SPEED CABLE is located INSIDE this cover!



Various bags include parts needed depending on your application and model number.



UBolt Universal bracket is loose fit within the parts bags. The CNC Machined bracket has a cardboard separator. Remove the bottom separator and remove the display mounting bracket (CNC Bracket Shown, your application may vary).



Installation Parts

PARTS BREAKDOWN:

The kit includes the following:

1) **6MMx12MM Metric Magnetic bolt** mounts on the front DRIVERS side wheel HUB with bracket and clamp. (Install sheets may detail drilling the hub)



1) **Speed Sensor** that mounts on the AXLE (either a 65" long 10MM BOLT or or 65" long PLASTIC TAB speed Sensor depending on your application).



1) **Power Wires** that connects to your 12Volt accessory system to provide backlight and LED power. This cable also used for Battery Voltage reading.



1) **Temp Sensor** mounting to the electric motor field coil bolt or to a 10mm bolt on a gas engine golf cart.



1) **Temp Sensor Extension Cable** from the motor to display.



1) **Bag Misc. Hardware**

1) **Display Mount Bracket, Hardware**
 *EXRAY-UBOLT Universal Bracket
 *EXRAY-Mxx CNC Machined
 MEZ Ezgo, MCC ClubCar, MYAM, etc.

> See end of this book for model number breakdown.

Display Installation

STEERING COLUMN MOUNTS:

Most installations will be on the Golf Cart Steering column using the either the universal mount EXRAY-UBOLT, or optional CNC 6061-T6 Aluminum bracket EXRAY-MEZ. (Optional dashboard mounting will include separate installation instructions).

Universal Bracket Mount EXRAY-UBOLT EXRAY-UXRT

The UBM will fit on all column diameters from 1" to 3" (Depending on the clamp used).

Note: Some vehicles with plastic column cover may require cutting for secure installation.

The parts shown include (2x) rubber grommets inserted into the bracket mounting holes, (2x) 4mmx0.7x12mm metric screws. Metric Allen wrenches will be needed. (See parts sheet)

The RED inserts are inserted into the rubber grommets as shown to the right. These are stops to prevent the screws from damaging the display. The RED FLAT BACK is farthest away from the display.

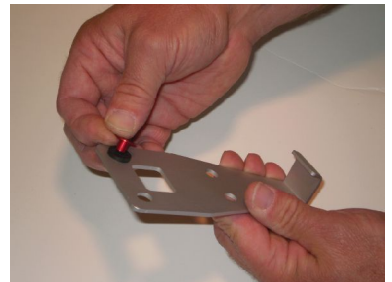

Display Installation

Universal Bracket Mount:

Lay a soft cloth on the work surface and lay the display face down. Install the Display using the two 4mm x 12mm Allen head screws.

Notice the red flat back is the bump stop, the screws will stop when fully compressed. The RED FLAT BACK is farthest away from the display.
> DO NOT OVER TIGHTEN!

Install the pipe clamp onto the steering column.

Position the display 6 inches (150mm) behind the steering wheel, about 1 inch (25mm) away from the steering wheel mounting hub.

Hand tighten the clamp bolt until the display no longer moves and aligned straight.

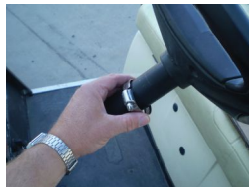

Display Installation

CNC Bracket Mount:

Steering tube column diameters vary between golf cart manufacturers, ensure you have the correct diameter before starting the project. (Example: the 1.50" EZ-Go tube uses 1.51" Clamp)

MODELS:

- EXRAY-MEZ EZ-Go 1.51"
- EXRAY-MEZ-EZ RXV 1.59"
- EXRAY-MCC ClubCar 1.66"
- EXRAY-MYAM Yamaha 1.71"

- EXRAY-MCCP ClubCar with Plastic Tube 1.76"

- EXRAY-MXRT-850E (ELEC)
EXRAY-MXRT-850G (Gas)
ClubCar XRT with Plastic Tube 1.76"

The parts shown include; (2x) rubber grommets - GROOVE snapped OVER THE LIP in the bracket mounting holes, (2x) 4mm x 12mm metric screws. (Metric Allen wrenches will be needed (not included))

The RED inserts are inserted into the DEEP DRILLED HOLE section. These are stops to prevent the screws from bottoming out and damaging the display. The RED FLAT BACK is farthest away from the display inside the drilled pocket.

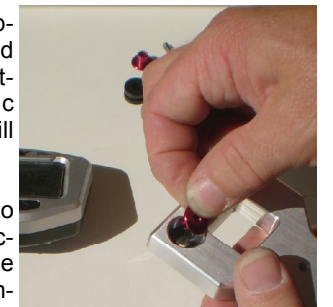

Display Installation

CNC Bracket Mount:

Lay a soft cloth on the work surface and lay the display face down. Install the Display using the two 4mm x 12mm Allen head screws.

Notice the red flat back is the bump stop, the screws will stop when fully compressed.

> DO NOT OVER TIGHTEN!

Insert the two 6mmx40mm Allen head bolts (Cap Screws) with 1-flat washer. (Note bolts may differ from picture)

Position the display 6 inches (150mm) behind the steering wheel, about 1 inch (25mm) away from the steering wheel mounting hub.

Hand tighten the 6mm bolts until the display no longer moves and is straight.

CLUB CAR with plastic tube see next page. (MCCP and MXRT Models)

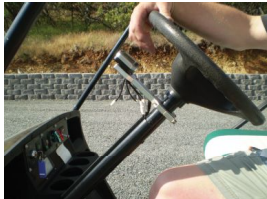
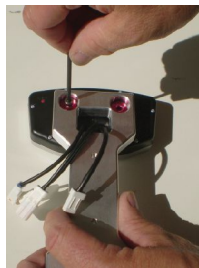

Display Installation

Steering Column Mount:

Some Club Car models utilized plastic tube covers. The diameter of the CNC bracket accounts for this tube and uses 45 degree "Stake bolts" which lock the display in place. This process will "ding" the plastic tube permanently, but necessary to lock the display in place.

Club Car with plastic cover: (MCCP and MXRT Models)

Tighten the bottom 6mmx40mm bolts as shown on the previous page.

Insert the two 6mmx20mm (or 6mmx25mm bolts, which ever came with your kit) into the 45 degree staking holes. Hand tight them to just touch the plastic tube. Then making sure the display is straight up, 1/4 turn each bolt side. Do not overtighten.

The display should be inside the steering wheel window. If the display is too high, move it farther away down the steering column and tighten.

Note: Some stainless steering covers differ in size. The tube may need to be cut to allow the EX-RAY to fit directly onto the steel steering column. Measure tube diameter.



Temp Sensor Installation

Temp Sensor Mount:

Electric Motor: Two options: 1) Motor field coil bolt or secure using the included Aluminized tape. (Both methods shown)
Gas Engine: 10mm bolt (optional water jacket sensor available, contact your dealer for more info).

ELECTRIC MOTOR:

The temperature sensor monitors the field coil temperature, an indication of $>75^{\circ}\text{C}$ (167°F), the internal temperature is too hot.

Option 1: Performed by authorized personnel, Carefully remove the motor field bolt and install the temp sensor. Install the bolt and torque to manufacturers specifications.



Option 2: Use the supplied tape, clean the area with de-grease agent, dry, and apply the tape over the sensor and part of the wire.

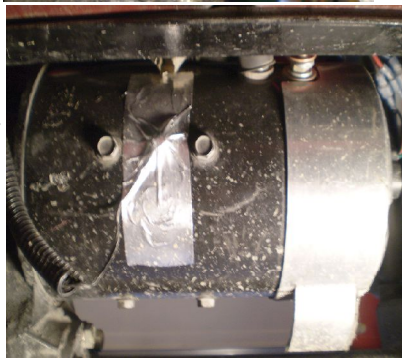

GAS ENGINE Temp Sensor Installation

The Golf Cart gas engine Temp Sensor:

The typical installation is for Air Cooled engines. Cylinder Head temperature is most critical. Oil temperature is also a good indicator. Find a location that a bolt can safely be removed and temp sensor can be installed.

GAS MOTOR:

Any bolt near the cylinder head will provide good indication. (Preferably a mounting bolt that does not require re-torquing the head bolts).

CAUTION: THE CABLE MUST NOT CONTACT MUFFLER EXHAUST COMPONENTS!

Secure the cable with cable clamps. Watch for CHAFFING points that may damage the cable.

Follow the EXTENSION CABLE guidelines to properly route the cable to the display.

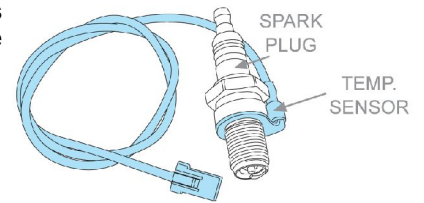

Cylinder Head Temperature Sensor for air-cooled machines

Temp Sensor EXTENSION Installation

Temp Extension Cable:

Install and use the supplied cable ties to secure the 6 foot temperature extension cable. Ensure the connectors are securely attached, do not apply any stress on the wires as the motor moves up and down.



INSERT THE CONNECTORS



TAPE THE SPLIT LOOM (NOT SUPPLIED)

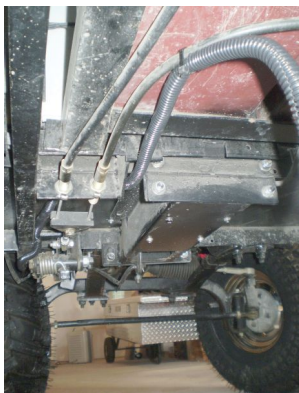

FACING FORWARD



FACING REARWARD

Temp Sensor EXTENSION Installation

Temp Sensor Extension Cable:

The cable routes to the Digital Speedometer display through the front floor board. Golf Cart Models vary, pictures below are typical - your cart may look different.

ELECTRIC MOTOR:

Route the cable through an opening through the steering column opening.

CAUTION: THE CABLE MUST NOT CONTACT THE MOVING STEERING KNUCKLE!

Secure the cable with cable clamps. Watch for CHAFFING points that may damage the cable.

Feed the connector through the TOP of the steering column. Let cable hang for now. (The speedometer cable must be installed first shown on the next several pages)

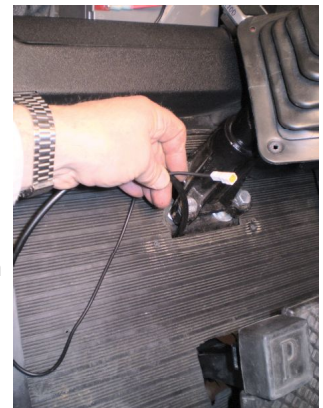
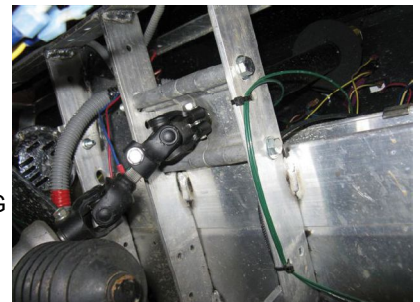

SPEED Sensor BOLT Installation

10mm BOLT SPEED Sensor Installation (Most all):

Speed sensor is a magnet and wheel speed sensor. The sensor mounted on the steering knuckle and magnet on the rotating wheel. Various small brackets are supplied best suit your application. EZ-GO shown below. YAMAHA & ClubCar & Jakes Disc following pages. SHORT HUBS require special bracket (pg 25).

BOLT SENSOR - AXLE Mount:
Remove the Drivers side wheel,
SUPPORT WITH SAFETY JACK

CAUTION: DO NOT PERFORM THIS PROCEDURE ALONE. ENSURE A STABLE SAFE WORK ENVIRONMENT.



Mount the 6mm x 19mm Magnet bolt. Some brackets may require the extra 6mm "Jam Nut".



DO NOT OVER TIGHTEN this bolt. It only needs to support its own weight.

Position the Clamp head and magnet bracket **OPPOSITE** of each other onto the wheel hub and tighten clamp. This will offset any weight balance.

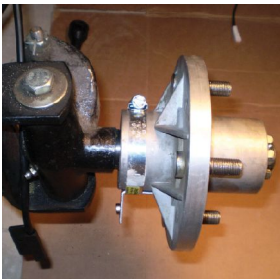

SPEED Sensor BOLT Installation

BOLT SENSOR - AXLE Mount (Most all):

Locate the appropriate bracket with 10mm hole with two 10mm JAM nuts. Various brackets used for different golf carts and steering arm knuckles. (Lifted EZ-GO Shown)

CAUTION: THE CABLE MUST NOT CONTACT THE MOVING STEERING KNUCKLE!

Carefully bend the cable and secure the cable with cable ties. Watch for **CHAFFING** points that may damage the cable.

Add Cable ties to secure the cable to the tie rod arm shown below.

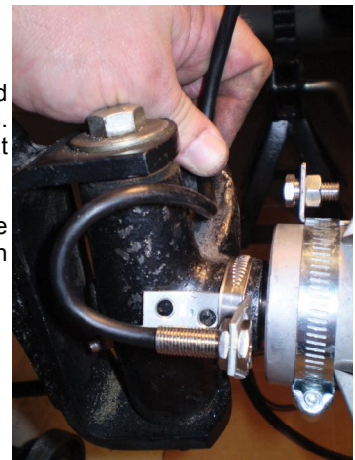
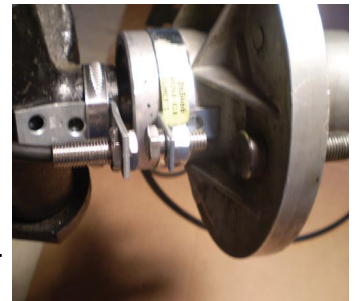

SPEED Sensor BOLT Installation

BOLT SENSOR-AXLE Mount (Most all):

Route the cable to prevent contact with the wheel. The full LEFT and full RIGHT turn stops should be checked to ensure the cable is not pinched, binds, or rubs.

CAUTION: THE CABLE MUST NOT CONTACT THE MOVING STEERING KNUCKLE OR TIRE!



Secure the cable with cable clamps. Watch for CHAFFING points that may damage the cable. Always use TWO cable ties side by side (should one break in the future)



ROTATE THE STEERING FULL LEFT LOCK TO FULL RIGHT LOCK, CHECK FOR CABLE PINCH HAZARDS!

Feed the connector over the TOP of the steering column. Let cable hang for now. (as shown in the Temp Extension Cable Installation section)



SPEED Sensor BOLT Installation

BOLT SENSOR - YAMAHA G2-G22-DRIVE, EZGO SHORT HUB AXLE Mount:

The short hub axles (with BLACK bearing cap) have no room to mount the 6mm magnet sensor with a clamp. **YAMAHA G2-G19 Shown (YAMAHA G22-DRIVE Similar)**

Either replace with aftermarket bearing hubs - or use the "magnet extension bracket" and drill the bearing hub as shown.

Use a drill guide (1/8" or 3.15mm thick plastic), lay across the top wheel lugs, draw a line using permanent marker. MARK TOP and BOTTOM as shown.

Measure from the LEFT EDGE 2.4 inches (2-3/8" or 61mm) and mark the hub. This will be the pilot hole.

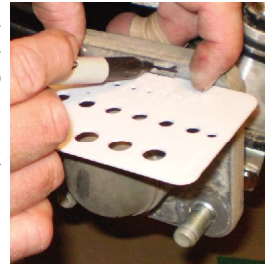

Mark above and below as shown.

SPEED BOLT Sensor Installation

BOLT SENSOR - YAMAHA G2-G22-DRIVE, EZGO SHORT HUB AXLE Mount:

Use a 13/64" (5mm) Drill Bit (no larger than 7/32" or 5.5mm) to drill a pilot hole at 2.4" (61mm) from left edge - drill BETWEEN THE LINES marked earlier.

The objective is drill a hole between the ridges behind the hub as shown.

See Below: The 10-24x1" (5mm) mounting screw is a **COUNTER-SUNK**, use a larger bit 13/32" (10mm) or 7/16" (11mm) just deep enough to countersink the screw.

DO NOT DRILL ALL THE WAY THROUGH !



SPEED BOLT Sensor Installation

BOLT SENSOR - YAMAHA G2-G22-DRIVE, EZGO SHORT HUB AXLE Mount:

Gather the parts for the 6mm x 19mm Mag mount. TWO 6mm nuts will be needed, 1-LOCK nut and 1-JAM nut for the magnet.

YAMAHA G2-G19 Shown, newer 2003-2008 G22-2008-and up YDR DRIVE hubs are similar.

Use the 10-24x1 (or 5mm x 25mm) countersunk screw, bracket, flat washer and nuts. Secure but do not over tighten.

Place a 6mm JAM nut on the 6mm x 19mm Magnet, insert the magnet in the bracket, attach the lock nut. Hand tighten for now. It will be adjusted after the sensor is mounted.

The bracket may be slightly **ANGLED REAR-WARD** as shown. This is normal.

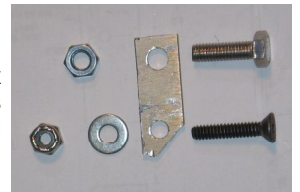

SPEED Sensor BOLT Installation

BOLT SENSOR - CABLE INSTALL

YAMAHA G2-G19, G22, Drive,
and EZGO "SHORT HUB":

SHORT AXLE SEE PAGE 29:

>EZGO "SHORT HUB"
2008+ RXV Driver Knuckle
PN#607413 (or similar)

>EZGO MED-TXT 2001-UP
#70673-G03P

>YAM G2-G19 Short Stub
Driver side Knuckle Part#
JN6-F3511-00-00 (or similar)

Install Magnet Page
25-27, then select your
hub Install:



YAM 2002 G2-G19 and
older, and EZGO use a
short stub axle shaft
(Pg 29)

LONG AXLE SEE PAGE 31:

>YAM G22, 2003 - 2007,
YDRA-YDRE 2007-UP
Driver side Knuckle Part#
JUO-F3511-01-00

>YAM YDRA - YDRE (DRIVE) 2011,
Driver side Knuckle Part#
JUO-F3511-10-00



YAM 2003 and up G22,
YDRA and YDRE (Drive)
use a **long stub axle** shaft.
(Pg 30)

SPEED Sensor BOLT Installation

**BOLT SENSOR - SHORT
YAMAHA G2-G19, EZGO
SHORT HUB SENSOR Mount:**
Locate the X-90° TAB bracket as
Shown

YAM G2-G19 as Shown YAM G22-YDR See Page: 30

Mount the Speed Sensor 10mm
BOLT with two jam nuts onto the
bracket, move the speed sensor so
very little protrudes as shown.



Mount the bracket to the REAR
WARD bolt on the steering knuckle.
Shown is a LIFTED cart with spacer
block, but stock OEM will install onto
the same rear bolt. Re-tighten the
bolt to OEM Specifications.



Adjust BOTH 6mm Magnet and
10mm Speed Sensor for 1/4"
(6 to 7mm) gap (the width of cable
tie sideways).

SLOWLY rotate the hub and
check for any interference that
could damage the 6mm mag-
net or Sensor with **at least 1/4"**
**(6 to 7mm) space between ANY
object.**

**Gap assumes the carts bearings
are in good working order.**



SPEED Sensor BOLT Installation

BOLT SENSOR - LONG YAMAHA G22-DRIVE LONG AXLE SENSOR Mount:

Locate LONG L-90° TAB bracket
YAM G22-YDR as shown
YAM G2-G19 See Page 29



Mount the Speed Sensor 10mm BOLT with two jam nuts onto the bracket, move the speed sensor so 3/4" protrudes as shown.



Mount the bracket to the REAR WARD bolt on the steering knuckle. as shown (LIFTED cart with spacer block similar). Re-tighten the bolt to OEM Specifications.

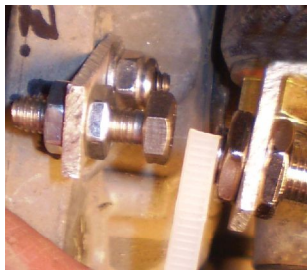

Adjust BOTH 6mm Magnet and 10mm Speed Sensor for 1/4" (6 to 7mm) gap (the width of cable tie sideways).

SLOWLY rotate the hub and check for any interference that could damage the 6mm magnet or Sensor with **at least 1/4" (6 to 7mm) space between ANY object. Gap assumes the carts bearings are in good working order.**



(Photos Courtesy of Customer Install, 2010 YDRA, JS of Florida)

30

Use 2 Zip ties to steering arm, go to next page...

SPEED Sensor BOLT Installation

BOLT SENSOR - CABLE ROUTING (ALL EZ, YAM G2 - DRIVE, etc.)

Route the cable to prevent contact with the wheel. The full LEFT and full RIGHT turn stops should be checked to ensure the cable is not pinched, binds, or rubs.



CAUTION: THE CABLE MUST NOT CONTACT THE MOVING STEERING KNUCKLE OR TIRE!

Secure the cable with cable clamps. Watch for CHAFFING points that may damage the cable. Always use TWO cable ties side by side (should one break in the future)



ROTATE THE STEERING FULL LEFT LOCK TO FULL RIGHT LOCK, CHECK FOR CABLE PINCH HAZARDS!

Feed the connector over the TOP of the steering column. Let cable hang for now. (as shown in the Temp Extension Cable Installation section)

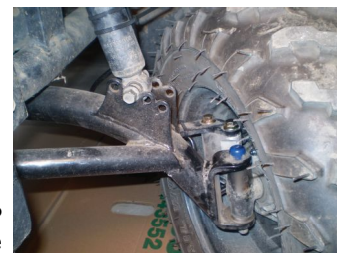

SPEED Sensor BOLT Installation

BOLT SENSOR - JAKE'S DISC BRAKES: (Most all models):

Pictures shown off the vehicle but can be performed on the vehicle, drivers side.

Mount the magnet into the SHORT bracket as shown and use the DISC mounting stud, hand tight for now.

Mount 10MM Speed Sensor to the LONG bracket with two jam nuts. Align the 10MM sensor as shown to mark a drill spot. Drill into the Drivers side Disc Brake bracket 1/4" (6.6mm) hole.

Adjust BOTH 6mm Magnet and 10mm Speed Sensor for 1/4" (6 to 7mm) gap (the width of ZIP cable tie).

SLOWLY rotate hub checking for interferences that could damage the 6mm magnet or Sensor - **at least 1/4" (6 to 7mm) space between ANY object. TIGHTEN ALL BOLTS.**

Gap assumes the carts bearings are in good working order.

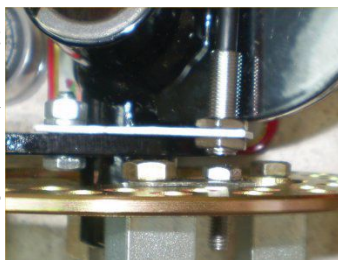
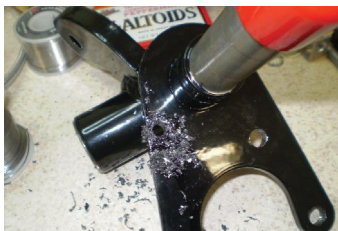

SPEED Sensor BOLT Installation

BOLT SENSOR - JAKE'S DISC BRAKES: EZGO SHOWN (others similar):

Secure the cable with cable clamps. Watch for CHAFFING points that may damage the cable. Always use TWO cable ties side by side (should one break in the future)

CAUTION: THE CABLE MUST NOT CONTACT THE MOVING STEERING KNUCKLE OR TIRE!

Route the cable to prevent contact with the wheel. The full LEFT and full RIGHT turn stops should be checked to ensure the cable is not pinched, binds, or rubs.

ROTATE THE STEERING FULL LEFT LOCK TO FULL RIGHT LOCK, CHECK FOR CABLE PINCH HAZARDS!

Feed the connector over the TOP of the steering column. Let cable hang for now. (as shown in the Temp Extension Cable Installation section)



SPEED Sensor BOLT Installation

BOLT SENSOR - LIFTED CLUB CAR or JAKE'S LIFT KIT / HUB AXLE Mount:

The Club Car with 6 inch spindle lift, or most Jakes Lift kits with angles spindle axles require the 30' Degree bracket (supplied).

Mount the Speed Sensor 10mm BOLT with two jam nuts onto the bracket, move the speed sensor so very little protrudes.

Mount the bracket to the steering knuckle with a cable clamp. Shown is a LIFTED Club Car cart with angled axle knuckle. (Most Jake's kits are angled in similar manner). The 10mm Sensor will be angled slightly. This is normal.

Adjust BOTH 6mm Magnet and 10MM Speed Sensor until 1/4" (6 to 7mm) space (the width of cable tie).



SLOWLY rotate the wheel hub and check for any interference that could damage the 6mm magnet.

MUST be at least 1/4" (6 to 7mm) space between ANY object.

This assumes the carts bearings are in good working order.

SPEED Sensor BOLT Installation

BOLT SENSOR - LIFTED CLUB CAR or JAKE'S LIFT KIT / HUB AXLE Mount:

Attach cable ties to the steering arm. Rotate the steering wheel FULL LEFT and FULL RIGHT and check for binding.

Route the cable as described earlier.

CAUTION: THE CABLE MUST NOT CONTACT THE MOVING STEERING KNUCKLE OR TIRE!

Secure the cable with cable clamps. Watch for CHAFFING points that may damage the cable. Always use TWO cable ties side by side (should one break in the future).

Mount the wheel and recheck for rubbing or any damage that may occur to the cable.

Feed the connector through the TOP of the steering column. Let cable hang for now. (as shown in the Temp Extension Cable Installation section)



XRT-850E SPEED Sensor TAB Installation

**TAB SENSOR - CLUBCAR
XRT-850E HUB AXLE Mount:**
The XRT requires a special TAB speed sensor mounted to the cast iron steering knuckle.

XRT-850G (GAS) comes with its own separate instruction sheet.

MAGNET MOUNT:
The 6mm x 19mm magnet mount is the same as previously described.

Mount the 6mm x 19mm Magnet bolt. Some brackets may require the extra 6mm "Jam Nut".

DO NOT OVER TIGHTEN this bolt. It only needs to support its own weight.

Position the Clamp head and magnet bracket **OPPOSITE** of each other onto the wheel hub and tighten clamp. This will offset any weight balance.

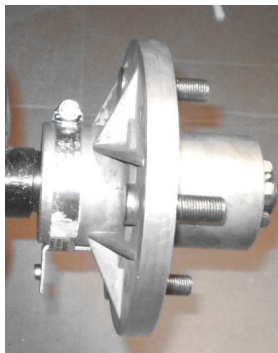
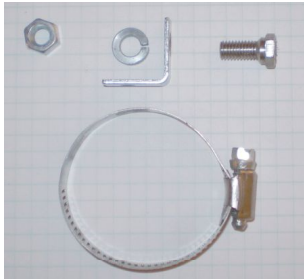

XRT-850E SPEED Sensor TAB Installation

TAB SENSOR Continued:
Mount the TAB Speed Sensor to the supplied bracket using the two 4mm x 12mm countersunk screws with NYLOC nut as shown.

Mount the bracket to the **REAR WARD** edge of the drivers side steering knuckle.

The Size 36-40 hose clamp (or 2 clamps together) around the **TOP 1/2"** (13mm) of the bracket between the sensor wire and the mounting bracket. Loosely tighten the clamp We will need to adjust this after the magnet is installed.

Adjust the TAB Sensor so the **MAGNET** passes through the "bottom" edge of the sensor, with **1/4"** (6 to 7mm) space (the width of cable tie).

SLOWLY rotate the hub and check for any interference that could damage the 6mm magnet. **MUST be at least 1/4"** (6 to 7mm) space between **ANY** object.

This assumes the carts bearings are in good working order.

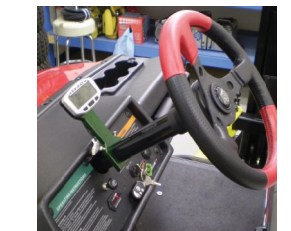
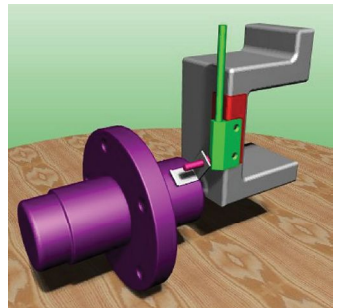

Power Wire (Optional) Installation

EXTERNAL POWER WIRES:

The external power cable **KIT-EXRAY-PWR** provides power to the backlight and two warning LED. The supplied wire must be connected to a FUSED 12-48 VOLT CIRCUIT. (Cable assembly may vary from photo).



This circuit is best connected to the KEY SWITCHED power, when turned off disables the display. However, display will automatically turn off after 20 minutes of no activity if connected to a live circuit. Ring and Faston jumper terminals are included in your kit.

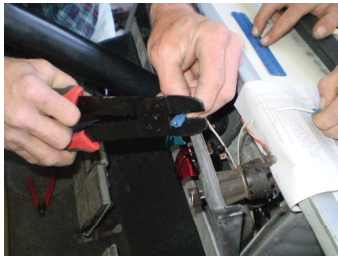

Route the cable through to the dashboard described earlier and connect to a FUSED 12-48 Volt DC circuit.



CAUTION: THE CABLE MUST NOT CONTACT THE MOVING STEERING KNUCKLE!

Wiring Column Protector Installation

Wire Harness Protection:

The wires are routed along the TOP of the steering column. A optional protection tube covers the wires and offers a clean installation look. **EDT LLC MODEL: HDW800-006-CPT**

Carefully attached all the connectors. Make sure the fragile wires are NOT STRESSED. Leave a little slack. ** Use cable ties to secure the wires to the steering column **

Snap the optional column protector in place, careful not to pinch any wires. (Display removed for clarity in this picture.

Installation Complete. (Optional CNC machined bracket Model **EXRAY-MEZ** shown)

Proceed to the SETUP PROCEDURE.



NOTE: GEN-2 Silver and GEN-3 Black EX-RAY displays are similar mounting

Tire Wheel Size Calculation

Calculating Proper Tire Size:
Four methods to set the proper size which determines speed. The number needed in the computer is in millimeters.

Method 1) Easy Ruler Method:

Find the circumference of the front wheel by measuring its diameter in millimeters. (An inch to conversion is available in the back of this booklet)

Multiply the wheel diameter by 3.14. The result is your tire size.
Example: [INCH x 25.4 = mm]
So 21.4" tall x 25.4 = 545mm
545mm x 3.14 = 1706mm



Method 2) Rolling Measurement:

On a flat surface, mark the tire sidewall (with the speed sensor mounted) and the ground with a marking pen or chalk. Roll the wheel until the mark on the tire completes 1 revolution and back on the ground. Mark the ground at this location. (Driver should be in the car at the time)

Measure the distance between the marks on the ground and convert the measurement to millimeters (multiply INCH by 25.4 to get mm). Use this number for your wheel size. For accuracy, the drivers weight should be on the cart when making this measurement.

Tire Wheel Size Calculation

Method 3) Distance Measurement:

For the most accurate measurement, use wheel size measurement from Method 2 or set the wheel size to 1700 for lifted carts (20-22 inch tires) and 1435 for stock 18 inch wheels.

1. Find a length of road where the distance is known. (GPS is a best choice for accurate measurement).
2. Drive the distance and note the distance on the speedometer display. For example, the road is known to be 5 miles and the speedometer reads 4.95 miles. (drive more than 2-3 miles)
3. Use the numbers to solve for X in the following equation:

$$\frac{1675}{X} = \frac{4.95}{5.00} \quad \text{or} \quad \frac{(\text{current wheel size})}{(\text{new wheel size})} = \frac{(\text{current miles})}{(\text{actual miles})}$$

$$4.95X = 1675 * 5.00$$

$$4.95X = 8375$$

$$X = \frac{8375}{4.95}$$

$$X = 1691$$

Enter the new number from above method into the Speedometer (Described later in this booklet) Record this number below.

My Tire Size is:

--	--	--	--

Tire Wheel Size Calculation

Method 4) Tire Chart Quick Set:

The chart below picks typical tire sizes and performed calculations. This is a reference and if accurate data is required, or speeding tickets can be issued, the previous methods 1-3 must be used.

REMEMBER TO WRITE DOWN YOUR FINAL SETTINGS!

Tire size inches x 25.4 = Size in mm

Tire size in mm x 3.14 = Total Diameter size of tire

Tire Size	Tread	Typical Types	SIZE mm
18	Turf	OEM Stock	1395-1435
20	All Terrain	Alltrail, Trailwolf	1550-1595
20	Mudd	Trail wolf (measured 1580)	1565-1595
22	All terrain	AllTrail	1725-1760
22	Mudd	Stryker (measured 1775), Mudbuster, Carlisle 489	1755-1775
23	All terrain	AllTrail	1800-1830
23	Mudd	Carlisle 489	1830-1850
25	All terrain	Alltrail	1955-1980
25	Mudd	Carlisle 489	1980-1995

Tire manufacturer trade names shown above for reference only.

WARNING: This is an example chart, tire pressure, vehicle weight, and other factors affect speed readings. If accuracy is required, use a GPS and the previous page examples.

DATA SETTING MODE

Overview:

For the EX-RAY to operate correctly, the DATA SETTING must be correct.

Available Settings:

- Kilometers or Miles per Hour
- Wheel size in millimeters
- 12 hour or 24 hour Clock Format
- Time of Day
- Temperature unit of Measure, °F or °C
- Maintenance Reminders (M/K)
- Battery Voltage (12, 24, 36, and 48V systems)

After setting is confirmed, EX-RAY will move on to the next setting in order. If no button is pressed for 13-15 seconds, EX-RAY will return to Normal Mode.

Enter Data Setting Mode:

> TO ENTER DATA SETTING MODE, PRESS AND HOLD ALL THREE BUTTONS FOR 3-SECONDS:

All digits will turn on. Release the buttons to continue.

YOU ONLY HAVE 13-15 SECONDS TO STEP THROUGH BEFORE RESETS TO NORMAL SCREEN 1.

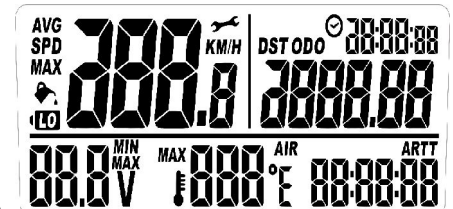

Data Setting

Program Kilometers or Miles Per Hour:

To cycle between KMH and MPH press the left button.

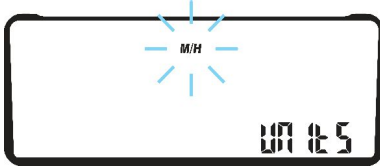

TO CONFIRM PRESS THE CENTER BUTTON.
EX-RAY will go to the next screen



Program Wheel size:

See "Measuring Wheel Size" section for more information.

FACTORY DEFAULT #2109
Enter Wheel Size determined in
wheel size section.



MODIFY FLASHING DIGIT BY
PRESSING THE LEFT BUTTON



CHANGE TO THE NEXT DIGIT BY
PRESSING THE RIGHT BUTTON



TO CONFIRM PRESS THE CENTER
BUTTON. EX-RAY will go to the next
screen.



Data Setting

Program 12 or 24 Hour Clock:

EX-RAY factory default is 12 hour format..

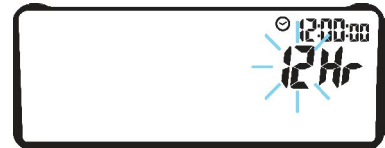

TO CYCLE BETWEEN 12 AND 24 HOURS,
PRESS THE LEFT BUTTON



TO CONFIRM PRESS THE CENTER BUTTON.
EX-RAY will go to the next screen



Program Time of Day:



MODIFY FLASHING DIGIT BY
PRESSING THE LEFT BUTTON



CHANGE TO THE NEXT DIGIT BY
PRESSING THE RIGHT BUTTON



TO CONFIRM PRESS THE CEN-
TER BUTTON. EX-RAY will go to
the next screen.



Data Setting

Program Temperature Unit of Measure:

Choose between °C or °F.



TO CYCLE BETWEEN °C or °F HOURS,
PRESS THE LEFT BUTTON



TO CONFIRM PRESS THE CENTER BUTTON.
EX-RAY will go to the next screen



Program HIGH Temperature Warning:

As motor temperature sensor (Electric or Gas) reaches the value of this setting, the Amber left LED will turn on as a CAUTIONARY warning. Setting to 0 disables the alert. (Factory default = 0°)



MODIFY FLASHING DIGITS BY
PRESSING THE LEFT BUTTON.



CHANGE TO NEXT DIGIT BY
PRESSING RIGHT BUTTON.



TO CONFIRM PRESS THE CENTER BUTTON.
EX-RAY will go to the next screen



Data Setting

Program DANGER Temperature Warning:

As motor temperature sensor (Electric or Gas) reaches the value of this setting, the Right Red LED will turn on as a CRITICAL warning. Setting to 0 disables the alert. (Factory default = 0°)

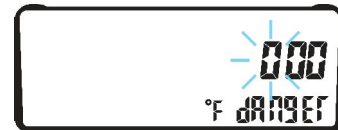

MODIFY FLASHING DIGITS BY PRESSING THE
LEFT BUTTON.



CHANGE TO NEXT DIGIT BY PRESSING RIGHT
BUTTON.



TO CONFIRM PRESS THE CENTER BUTTON.
EX-RAY will go to the next screen



Electric Motors: (Typical Settings - do not exceed 85°C)

- WARNING: 65°C (149°F)
- CRITICAL: 75°C (167°F)

Gas Engines: (Suggested warnings, see MFG)

- Spark Plug / Head Temp WARNING: See MFG
- Oil Temp WARNING: 82°C (180°F)
- Coolant WARNING: 99°C (210°F)

- Spark Plug / Head Temp CRITICAL: See MFG
- Oil Temp CRITICAL: 99°C (210°F)
- Coolant CRITICAL: 110°C (230°F)

See MFG = Check manufacturers recommendations

Note: Oil Temp varies depending on quality of oil.

Note: Head temperature and OIL properties, see article:

<http://nortonclub.org/docs/OilTemp.pdf>

Data Setting

Set Battery and Gas Maintenance Reminders:

Maintenance reminder used for either Gas or Electric golf carts to check the oil or add water to the batteries in an electric cart. Set the number of miles or kilometers left until EX-RAY displays the oil and wrench shaped reminder icons. After setting <OIL>, the <CARE> setting screen will appear. EX-RAY defaults to 0000.

MODIFY FLASHING DIGITS BY PRESSING THE LEFT BUTTON.

CHANGE TO NEXT DIGIT BY PRESSING RIGHT BUTTON.

TO CONFIRM PRESS THE CENTER BUTTON.

EX-RAY will return to normal mode after setting <CARE>

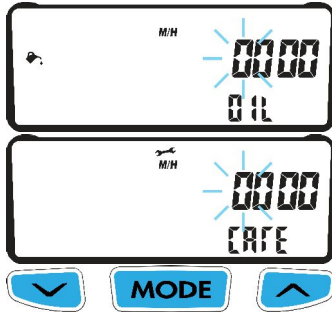

- Each km/mile the vehicle travels lowers the maintenance reminder values by 1.
- When a reminder countdown reaches 0 while driving, the respective icon will turn on (activate).
- EX-RAY will not increase the reminder value automatically, they must be increased in the data setting mode.
- When reminder settings screens are viewed in data setting mode, the icons will turn off if they have been activated.

Things that will not affect the maintenance reminders:

- Entering data setting mode
- Using the adjustable trip distance feature
- Resetting single ride data (distance traveled since last reset)

Data Setting

DC Warning:

A warning can be set to alert the operator when batteries are below this setting flashing the Yellow LED. Check with your battery manufacturer specifications. The following is general guidelines for LEAD ACID batteries:

12V Battery: Warning 10.5-11.0V (Gas vehicles)

24V Battery: Warning 21V

36V Battery: Warning 31.5V

48V Battery: Warning 42.0V

Setting to 0 disables the alert. (Factory default = 0 no warning)

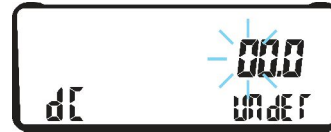

MODIFY FLASHING DIGITS BY PRESSING THE LEFT BUTTON.

CHANGE TO NEXT DIGIT BY PRESSING RIGHT BUTTON.

TO CONFIRM PRESS THE CENTER BUTTON. EX-RAY will go to the next screen.

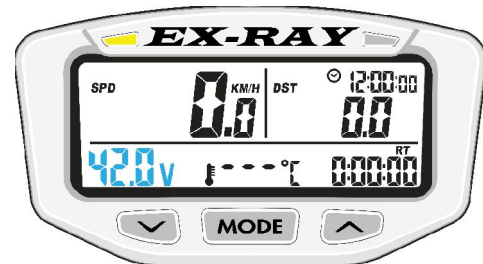
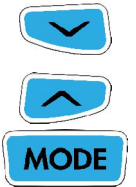

Data Setting

DC Danger

As batteries are depleted below a certain voltage, damage can occur. DC DANGER Level can be set to alert the operator the batteries are below this setting flashing the RED LED. Both the Yellow and Red LED will Flash. Check with your battery manufacturer specifications. The following is general guidelines for LEAD ACID batteries:

12V Battery: Warning 9.75V

24V Battery: Warning 19.5V

36V Battery: Warning 29V

48V Battery: Warning 39V

Setting to 0 disables the alert. (Factory default = 0 no warning)



MODIFY FLASHING DIGITS BY PRESSING THE LEFT BUTTON.



CHANGE TO NEXT DIGIT BY PRESSING RIGHT BUTTON.



TO CONFIRM PRESS THE CENTER BUTTON. EX-RAY will go to the next screen.

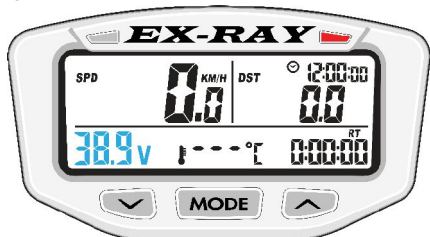

Data Setting

Avg Speed

Operator has a choice to place Average Speed between Screen 2 or Screen 3.

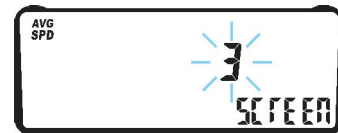

MODIFY FLASHING DIGITS BY PRESSING THE LEFT BUTTON.



TO CONFIRM PRESS THE CENTER BUTTON. EX-RAY will go to the next screen.



DST Distance Resolution

Distance resolution can be set in 1 or 2 place decimal. (Note: The speed sensor utilizes only one magnet and resolution does not increase accuracy at speeds below 2 miles per hour). Factory Default: 1.

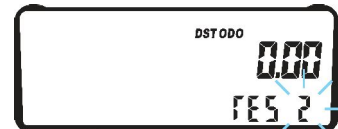

MODIFY FLASHING DIGITS BY PRESSING THE LEFT BUTTON.



TO CONFIRM PRESS THE CENTER BUTTON. EX-RAY will go to the next screen.



NORMAL MODE SCREENS

Switch between 3 Normal Mode Screens:

All of the information the EX-RAY provides is on one of these 3 screens.

When driving, the user has the choice of staying on screen 1 or screen 2. Screen 3 will default back to screen 1 after 5 seconds.

TO SWITCH BETWEEN SCREENS,
PRESS THE CENTER BUTTON



SCREEN 1:

Screen 1 displays:

- Speed (SPD)
- Distance (DST)
- Battery Voltage
- Ride Time (RT)
- Time of Day
- Engine Temperature (above 100°F)

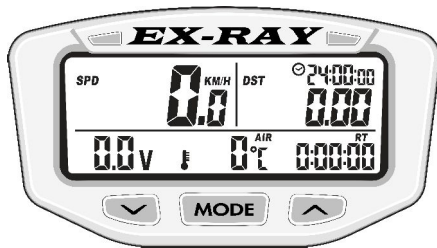

Normal Screen Modes

SCREEN 2:

Screen 2 displays:

- Speed (SPD)
- Distance (DST)
- Battery Voltage (V)
- Air temperature
- Stop Watch (TT)
- Time of Day

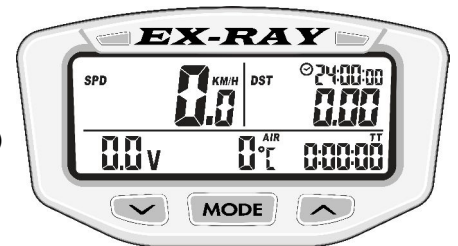

SCREEN 3-A:

Screen 3-A displays:

- Avg Speed (AVG S)
- Odometer (ODO)
- Min Voltage (MIN V)
- Max Motor / Engine Temperature
- Accumulated Ride Time (ART)
- Time of Day

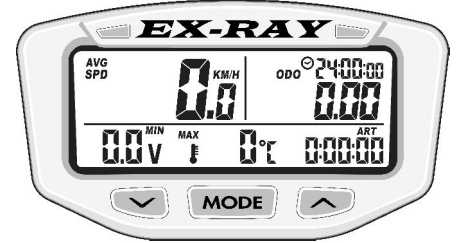

SCREEN 3-B:

Screen 3-B displays:

- Max Speed (MAX S)
- Odometer (ODO)
- MAX Voltage (MAX V)
- MAX Motor / Engine Temperature
- Accumulated Ride Time (ART)
- Time of Day



EX-RAY FEATURES

Overview:

The EX-RAY is in Normal Mode during regular use.

Available Features:

- Sleep Mode
- Speedometer (Speed, Average Speed, Maximum Speed)
- Distance (Odometer, Adjustable Trip Distance)
- Voltage (Battery voltage 12, 24, 36, or 48V systems)
- Clock (Time of Day, Ride Time, Stop Watch, Accumulated Ride Time)
- Temperature (Ambient Air and Electric Motor / Gas Engine)
- Reset single ride data to zero (distance traveled)

Sleep Mode:

If EX-RAY receives no data for 10-20 minutes (either wheel data or a button pressed), it will enter Sleep Mode. It will only display the clock while in Sleep Mode. It will exit Sleep Mode when it receives sensor data or a button is pressed.



EX-RAY Features

Speedometer:

DESCRIPTION: The speedometer shows vehicle speed. EX-RAY also shows average and maximum speed since last reset.

SPEED: Speed is displayed top left of SCREEN 1 from 4-299.9 M/H or KM/H. The SPD Icon and M/H or KM/H will also appear next to the speed reading.

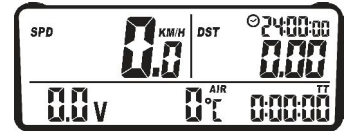

AVERAGE SPEED: Average Speed displays on SCREEN 2 next to the AS Icon. The Average speed the vehicle has traveled since the last reset.

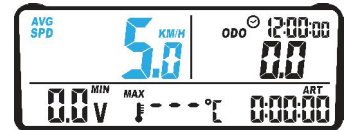

MAXIMUM SPEED: Maximum Speed displays on SCREEN 3 next to the AS Icon. The Average speed the vehicle has traveled since the last reset.



EX-RAY Features

Odometer:

DESCRIPTION: The Odometer shown on SCREEN 3 will provide the user with a numeric display of total accumulated distance in miles or kilometers. The odometer is not re-set able.

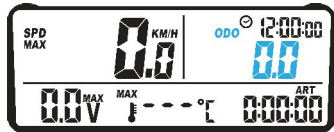

Trip Distance Meter:

DESCRIPTION: The Trip "DISTANCE" Meter shows how much distance has been traveled since the last reset. Valuable information for electric vehicles without fuel gauges or gas vehicles.

Trip Distance: Trip DISTANCE (DIS) is displayed on SCREEN 1 & 2 in the upper right corner beside the DST Icon.

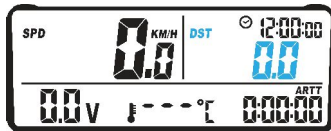

TO RESET TRIP DISTANCE, RESET SINGLE RIDE DATA BY HOLDING THE LEFT AND CENTER BUTTONS FOR 3-SECONDS



EX-RAY Features

Voltage:

DESCRIPTION: The Volt meter shown on SCREEN 1 o& 2 will provide the user with a numeric display of the actual battery voltage.

For gas powered vehicles, the 12V alternator, battery, and electrical health can be monitored.

For electric vehicle, monitoring battery pack voltage allows the user to monitor when the battery is depleted.

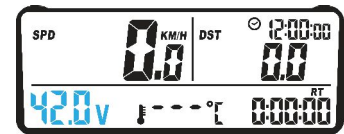

For 48V systems: The voltage display cannot read above 52.6VDC limited by its design.

If the voltage is above 52.6V, the reading will change to HI as shown below.

48V battery systems, when fully charged ,will drop below 52.6VDC in a matter of seconds under load.

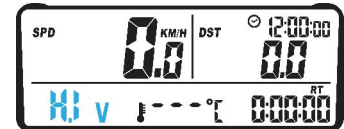

EX-RAY Features

Voltage:

DESCRIPTION: The Volt meter MIN-MAX is shown on SCREEN 3 will display minimum or maximum BATTERY VOLTAGE cycling every other second.

For gas powered vehicles, low voltage indicates the lowest level reached or alternator problems. Electric vehicles displays battery pack lowest level under load.

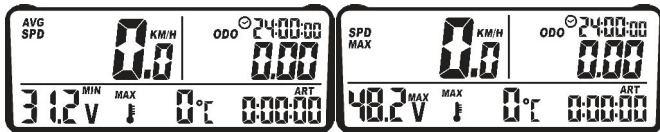

WARNING AND DANGER LEDS

When WARNING and DANGER levels were set for voltage, the LEDS will FLASH when those levels are exceeded. YELLOW LED will be on when voltage is BELOW the warning level. The RED-LED will FLASH when battery voltage is BELOW the danger level.



External power must be connected for the LED's to function

EX-RAY Features

Clock and Stop Watch:

Time of Day Clock:

The Time of Day Clock is displayed in the bottom right corner in all screens next to the Clock Icon and during sleep mode. The clock is displayed in either 12H or 24H format.

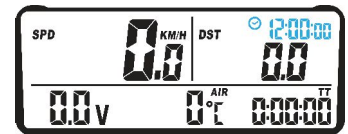

Stop Watch:

The Stop Watch (TT) is displayed on SCREEN 2. The Stop Watch functions like and simple stop watch. Press LEFT button to start or stop the stop watch.

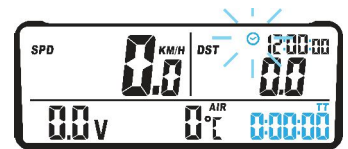

To RESET the Stop Watch, reset single ride data by holding the LEFT and CENTER buttons for 3 seconds.



EX-RAY Features

Ride Time:

DESCRIPTION: Ride Time is displayed SCREEN 1 bottom right corner. Ride Time shows how long the motor / engine has been running since the last reset.

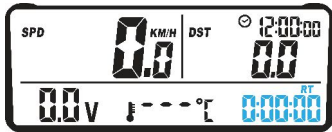

To RESET the Ride Time, reset single ride data by holding the LEFT and CENTER buttons for 3 seconds.



Accumulated Ride Time:

DESCRIPTION: Accumulated Ride Time (ART) tracks the total amount of time the vehicle has been in motion. Accumulated Ride Time is not re-set able. (Valuable for accounting for battery life time in EV or Gas Engine overhaul data)

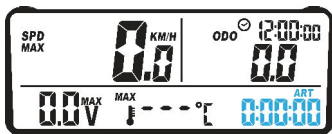

DISPLAY: The highest Accumulated Ride Time EX-RAY can display is 9999.59 hours (When the maximum value is reached, EX-RAY will not roll the number back to 0).

EX-RAY Features

Ambient Air Temperature / Motor-Engine Temp:

EX-RAY displays different temperature information on each of the three normal mode screens.

SCREEN 1: Electrical Motor / Gas Engine Temperature

SCREEN 2: Air (Ambient) Temperature

SCREEN 3: Maximum Electric Motor / Gas Engine temperature received by the sensor since the last reset.

Temperature LED's:

- When temperature reaches EX-RAY HIGH temp setting, the **LEFT AMBER LED** will light SOLID ON, signaling the motor is starting to get too hot.
- When temperature reaches EX-RAY DANGER temp setting, the **RIGHT RED LED** will light SOLID ON, signaling the motor is too hot and recommended to stop.
- Temperature measurements are based on user defined values to advise when the motor is getting too hot. Temperature cutoffs must be programmed manually. See DATA SETTING section.
- **EX-RAY must be connected to EXTERNAL POWER or LED's will not function.**



RIGHT RED LED:
Over Temp Alert

LEFT AMBER LED:
Temp Caution Alert

EX-RAY Features

Reset Single Ride Data to Zero:

Resets Temporary Data:

- Maximum Speed (MS)
- Stop Watch (TT)
- Ride Time (RT)
- Distance Traveled (DST)

The data should be reset to zero at the end of your trip so that new information can be logged on the next event.

Notes:

- The reset can be done from any screen
- Accumulated Ride Time and Odometer cannot be reset and are intended to maintain cumulative information.



To RESET the single ride data by holding the LEFT and CENTER buttons for 3 seconds.



EX-RAY MUST BE RESET TO RECOGNIZE SENSORS:

- If ANY wires become unplugged from EX-RAY, do a reset after everything is re-connected. (Power wire not included)
- Alternately, push RED RESET button on the back of the EX-RAY.

TROUBLE SHOOTING / FAQ

Frequently Asked Questions:

Why Does Nothing Work?

- Try the RESET button on the back of the display.
- The internal battery may be weak or dead.
- EX-RAY external power may not be properly connected.

Why doesn't the Motor / Engine temperature work?

- You must have the engine temperature sensor properly installed for this feature to function. Review installation procedures.
- If a wire has been disconnected and plugged back in, perform the reset by pressing LEFT + CENTER buttons (or the RED RESET button on the back of the display. **A data reset must be performed in order for EX-RAY to recognize the sensors if they become unplugged.**

Everything is working, but the (K)MPH reading is way off.

- The speed sensor / magnet may be installed incorrectly. Double check to make sure everything is set up right. See Sensor Installation Section.
- The wheel size setting may be incorrect. Please review wheel size measurement instructions section.

EX-RAY is not displaying information correctly.

- If the wires on the back of the EX-RAY become damaged, incorrect readings may be displayed.
- Avoid twisting, crimping, kinking, or otherwise abusing the wires.
- Voltage reads HI? For 48V systems, some regen event may raise the voltage above 52.6VDC, the reading will be HI but does not damage the display, limited by its current design. **Under normal loads, battery voltage will be below 52.6V.**

Trouble Shooting / FAQ

The screen is cracked or hazed.

- Did gasoline, de-greasers, or other chemical cleaners come in contact with the EX-RAY's screen? Some chemicals can damage the display or finish of the EX-RAY.

The backlight won't stay on.

- EX-RAY requires external power to the vehicles 12-48 volt electrical input (ignition / Key switched and fused) in order for the backlight to be continuously on. Review installation procedure (See POWER WIRE installation section)

EX-RAY's internal battery is dead.

- To replace the battery, use a small coin to unscrew the round panel on the back of the EX-RAY. Remove and properly dispose of the spent battery. Install a new battery of the same make. Make sure the POSITIVE POLE IS FACING UP. Replace with common watch style battery CR2302. See Parts and Features Section.

Why aren't the LED's working?

- EX-RAY requires external power from the vehicles 12-48 volt electrical input (ignition / key switched and fused) in order for the LED's to function. Review installation procedure (See POWER WIRE installation section)
- In Electric Vehicles, this voltage must be supplied by a fused circuit after the Key Switch. Battery voltages range from 12, 24, 36, and 48Vdc. This product will not work greater than 48Volt battery systems (<60Vdc) and may cause damage.
- Temperature and Voltage limit settings must be programmed manually. See Data Setting Section for details.

Inch to Metric Tire Size:

The following chart is calculations for tire size in mm entered into the EX-RAY. The tire size may vary with tire pressure, vehicle weight changes, etc. Use this chart for a starting reference. For more accurate speed measurements, utilize the methods described "Wheel Size Calculator" section.

Formula: Inch x 25.4 = mm x 3.14 = Actual tire size in mm.

Inch	mm	Tire Size	Inch	mm	Tire Size
10	254	798	21.5	546	1715
10.5	267	837	22	559	1755
11	279	877	22.5	572	1795
11.5	292	917	23	584	1834
12	305	957	23.5	597	1874
12.5	318	997	24	610	1914
13	330	1037	24.5	622	1954
13.5	343	1077	25	635	1994
14	356	1117	25.5	648	2034
14.5	368	1156	26	660	2074
15	381	1196	26.5	673	2114
15.5	394	1236	27	686	2153
16	406	1276	27.5	699	2193
16.5	419	1316	28	711	2233
17	432	1356	28.5	724	2273
17.5	445	1396	29	737	2313
18	457	1436	29.5	749	2353
18.5	470	1475	30	762	2393
19	483	1515	30.5	775	2433
19.5	495	1555	31	787	2472
20	508	1595	31.5	800	2512
20.5	521	1635	32	813	2552
21	533	1675	32.5	826	2592

GLOSSARY:

ACCUMULATED RIDE TIME (ART): The long term amount of time spent driving (all ride times added together). Cannot be reset.

ADJUSTABLE DISTANCE EDIT (ADST): Edit the distance traveled since the last trip data reset. For electric powered vehicles this can be very important data. For Gas powered golf carts without fuel gases, this can provide a known distance before refueling is required.

AVERAGE SPEED (AS): The Median (average) speed the vehicle has been traveling since the last trip data reset.

BACKLIGHT: The light brightens the LCD display for night time driving. Automatically comes on when power is applied to POWER input and speed sensor data is received.

BATTERY VOLTAGE: The LCD displays voltage is based on input to the external power cable. 12, 24, 36, and 48Volt dc battery systems. **Do not exceed 60VDC at any time.**

DATA SETTING MODE: The place to set EX-RAY's settings. Includes distance units, wheel size, clock format, time, temperature units, high temp setting, over temp setting, and oil/battery maintenance reminders.

DISTANCE (DST): The amount of distance covered since the last reset.

HIGH/OVER TEMP INDICATORS: The LED indicators will turn on when the electric motor or gas engine gets to hot or dangerously hot.

GLOSSARY:

MAINTENANCE REMINDERS (🔧🔌): User programmable countdown in miles or kilometers for oil, care, or battery maintenance in electric vehicles.

MAXIMUM SPEED (MS): Highest speed achieved since the last reset.

NORMAL MODE: EX-RAY's standard mode of operation.

ODOMETER (ODO): The total accumulated distance EX-RAY has traveled. The odometer is permanent and cannot be reset.

RIDE TIME (RT): Shows how long the electric motor or gas engine has been running since last reset.

SENSORS: The speed sensor works with the magnet to provide EX-RAY wheel data. A second temperature sensor provides critical motor temperature information to the driver.

SLEEP MODE: If EX-RAY does not receive any sensory information, it will go into sleep mode and only display to the clock.

SPEED (SPD): The current speed the vehicle is traveling.

STOP WATCH (TT): A short term regular stop watch.

WHEEL SIZE: Very important. Used to determine speed and distance, Refer to the Wheel Measurement Data Setting section for an accurate measurement.

EXRAY MODEL NUMBERS:

MODEL	DESCRIPTION
EXRAY-UBOLT Fits most all vehicles steering columns to 2.25"	EXRAY display Universal mount, 10mm BOLT Speed Sensor
EXRAY-UBOLT-EZ-RXV EZGO RXV AXLE ONLY	EXRAY display Universal mount, 10mm BOLT Speed Sensor
EXRAY-UBOLT-JAKES-BRK Jakes Disc ONLY	EXRAY display Universal mount, 10mm BOLT Speed Sensor
EXRAY-UXRT-850E Fits ClubCar XRT-850 ELECTRIC only	EXRAY Display, Universal mount, TAB Speed Sensor ClubCar XRT-ELECTRIC ONLY
EXRAY-UXRT-850G Fits ClubCar XRT-850 GAS only	EXRAY Display, Universal mount, 10MM BOLT-Speed Sensor ClubCar XRT GAS ONLY



XRT-850E

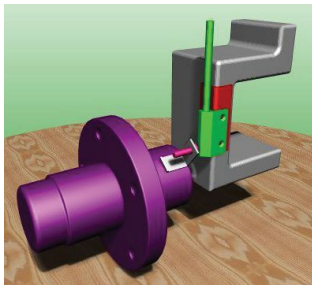

XRT-850G

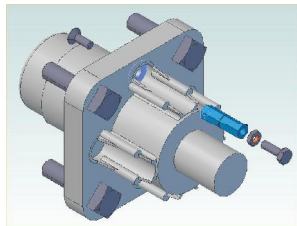

68

EXRAY MODEL NUMBERS:

MODEL	DESCRIPTION
EXRAY-MEZ EZGO 1.51" Steering column Diameter	EXRAY Display, CNC Machined mount, 10mm BOLT Speed Sensor
EXRAY-MEZ-RXV EZGO 1.59" Steering column Diameter	EXRAY Display, CNC Machined mount, 10mm BOLT Speed Sensor
EXRAY-MCC ClubCar 1.66" Steering column Diameter	EXRAY Display, CNC Machined mount, 10mm BOLT Speed Sensor
EXRAY-MYAM Yamaha 1.71" Steering column Diameter	EXRAY Display, CNC Machined mount, 10mm BOLT Speed Sensor
EXRAY-MCCP ClubCar 1.76" Plastic Steering column	EXRAY Display, CNC Machined mount, 10mm BOLT Speed Sensor
EXRAY-MXRT-850E ClubCar XRT ELECT 1.76" Plastic Steering column	EXRAY Display, CNC Machined mount, TAB Speed Sensor ClubCar XRT E ONLY
EXRAY-MXRT-850G ClubCar XRT GAS 1.76" Plastic Steering column	EXRAY Display, CNC Machined mount, BOLT Speed Sensor ClubCar XRT G ONLY



Jakes Disc Brake

69

EXRAY MODEL NUMBERS:

MODEL	DESCRIPTION
EXRAY DISPLAY	Replacement digital display head
KIT-EXRAY TEMP	ASY200-003-CHT, 10mm Temp sensor, ASY200-005-TMP, 84" extension cable
KIT-EXRAY PWR	Cable Power kit, 48", (EXRAY3 = 3-PIN)
KIT-SPD BOLT	Speed BOLT Sensor Kit, 65" cable 10mm
KIT-SPD TAB	Speed TAB Sensor Kit, 65" cable, XRT
KIT-EX-RXV BKT	RXV-Axle 10MM BOLT Bracket & HDWR
KIT-JAKES-BRK	Jakes disc bracket BRACKETS ONLY
KIT-CC XRT-850G	CRT-850G (Gas) Hub Mount Hardware
KIT-UNIV BKT	Universal Bracket mount w/hardware
KIT-MEZ	EZ 1.51" CNC Machined mount w/HDWR
KIT-MEX-RXV	EZ 1.59" CNC Machined mount w/HDWR
KIT-MCC	CC 1.66" CNC Machined mount, HDWR
KIT-MYAM	YAM 1.71" CNC Machined mount, HDWR
KIT-MCCP	CC 1.76" CNC Machined mount, HDWR for 1.76" PLASTIC TUBE, and CC-XRT
ASY200-003-CHT	10mm Temp sensor, 21" w/JST Conn
ASY200-005-TMP	Replacement 84 Temperature Sensor extension cable, w/JST Conn
MET350-009-BCK	Simple Universal display bkt no/hardware
EXRAY OP MAN	Operators manual, EXRAY GEN3
BATT-2032	Replacement CR2032 Lithium Battery

Setup Information

Maintenance Notes:

- Its a good idea to write down date of installation, maintenance, battery changes, warning settings, TIRE SIZE, or any settings that may help in the future to setup your EX-RAY.

Battery CR2032 Date:
Tire Size Vehicle Setting #
Temp Warning (Yellow LED):
Temp Danger (Red LED):
DC Warning (Under Voltage Warning):
DC Danger (Under Voltage STOP):
RES 1-2 (Resolution Speed):

Serial Number & Purchase Info

This is your Serial Number and manufacturing date of your EXRAY. Retain this manual and purchase receipt information for Warranty purposes. For RMA contact EDT at info@edt-exray.com or download from our web site:

<http://www.edt-exray.com/files/edt-doc-rma-form.pdf>

EX-RAY

LIMITED WARRANTY

Within 1 year from the date of purchase, EDT LLC, Will repair or replace, at it's option, any EX-RAY™ which is deemed defective in workmanship or materials.

Please contact the dealer where the EX-RAY™ was purchased for assistance. Retain Proof Of Purchase.

DISCLAIMER OF IMPLIED WARRANTIES:

EDT LLC SHALL IN NO EVENT BE LIABLE FOR DEATH, INJURIES TO PERSONS OR PROPERTY, OR FOR INCIDENTAL, CONTINGENT, OR CONSEQUENTIAL DAMAGES ARISING FROM THE USE OR MISUSE OF OUR PRODUCTS.

EXCEPT SPECIFICALLY PROVIDED HEREIN, THERE ARE NO OTHER WARRANTIES, EXPRESS OR IMPLIED, INCLUDING, BUT NOT LIMITED TO, ANY IMPLIED WARRANTIES OF MERCHANTABILITY OR FITNESS FOR A PARTICULAR PURPOSE. HOWEVER, SOME STATES DO NOT ALLOW LIMITATIONS ON HOW LONG AN IMPLIED WARRANTY LASTS, SO THE PRECEDING EXCLUSION MAY NOT APPLY TO YOU.

MADE IN AMERICA

— EDT.LLC —

Advanced System Designs

EX-RAY™

is a trademark of Energy Design Tek, LLC
PO Box 190, Merlin, Oregon, 97532. USA

www.edt-exray.com

Ph: 541-441-6123 / FAX: 541-479-4605

File: Doc140-026-B_OP-EXRAY3-Operators Manual.pdf
Revision B, 12/18/2016, Copyright ©2016

