

**SEPARATELY EXCITED (SX) TRANSISTORIZED MOTOR CONTROLLERS
FOR NEIGHBORHOOD ELECTRIC VEHICLE APPLICATIONS**

INSTALLATION AND OPERATION MANUAL

Flight Systems MODEL 51-FX503GXXX



Note: The information contained herein is intended to assist OEM's, Dealers and Users of electric vehicles in the application, installation and service of Flight Systems solid-state controllers. This manual does not purport to cover all variations in OEM vehicle types. Nor does it provide for every possible contingency to be met involving vehicle installation, operation or maintenance. For additional information and/or problem resolution, please refer the matter to the OEM vehicle manufacturer through his normal field service channels. Do not contact Flight Systems directly for this assistance.

March 2011

Table of Contents

Section 1.0	INTRODUCTION	3
1.1	Motor Characteristics	3
1.2	Solid-State Reversing.....	4
1.3	Flexible System Application.....	4
1.4	More Features with Fewer Components	4
Section 2.0	FEATURES OF SX FAMILY OF MOTOR CONTROLLERS	4
2.1	Performance.....	4
2.1.1	Oscillator Card Features	4
2.1.1.a	Standard Operation.....	4
2.1.1.b	Control Acceleration	5
2.1.2	Current Limit	5
2.1.3	Regenerative Braking to Base Speed.....	5
2.1.4	Auxiliary Speed Control.....	5
2.1.4.a	Field Weakening.....	5
2.1.4.b	Speed Limits	5
2.1.4.c	Top Speed Regulation	5
2.1.5	Ramp Start.....	5
2.1.6	On-Board Coil Drivers and Internal Coil Suppression	6
2.2	System Protective Override.....	6
2.2.1	Static Return to Off (SRO)	6

Table of Contents (Continued)

2.2.2	Accelerator Volts Hold Off.....	6
2.2.3	Pulse Monitor Trip (PMT).....	6
2.2.4	Thermal Protector (TP).....	6
2.2.5	Low Voltage	6
2.3	Diagnostics.....	6
2.3.1	Status Codes.....	6
2.3.1.a	Standard Status Codes.....	6
2.3.1.b	Stored Status Codes	6
2.3.2	Odometer Readings	6
2.3.3	RS-232 Communication Port	7
2.3.4	Circuit Board Coil Driver Modules.....	7
Section 3.0	ORDERING INFORMATION, ELEMENTARY AND OUTLINE DRAWINGS.....	8
3.1	Ordering Information for Separately Excited Controls.....	8
3.2	Outline: Package Size	9
3.3	Standard Elementary for Neighborhood Electric Vehicle Application.....	10
3.4	Standard Neighborhood Electric Vehicle Application Input/Output List.....	11
Section 4.0	TROUBLESHOOTING AND DIAGNOSTIC STATUS CODES.....	12
4.1	General Maintenance Instructions	12
4.2	Cable Routing and Separation	12
4.2.1	Application Responsibility	12
4.2.2	Signal/Power Level Definitions	12
4.2.2.a	Low Level Signals (Level L)	12
4.2.2.b	High Level Signals (Level H).....	13
4.2.2.c	Medium-Power Signals (Level MP).....	13
4.2.2.d	High-Power Signals (Level HP).....	13
4.2.3	Cable Spacing Guidelines	13
4.2.3.a	General Cable Spacing.....	13
4.2.4	Cabling for Vehicle Retrofits	13
4.2.5	RF Interference	13
4.2.6	Suppression.....	13
4.3	Recommended Lubrication of Pins and Sockets Prior to Installation	14
4.4	General Troubleshooting Instructions	15
4.5	Traction Controller Status Codes.....	16-29
Section 5.0	SET UP FUNCTIONS FOR TRACTION CONTROLLER.....	30-33
Section 6.0	MEMORY MAP.....	34-36

Section 1. INTRODUCTION

Section 1.1 Motor Characteristics

The level of sophistication in the controllability of traction motors has changed greatly over the past several years. Vehicle manufacturers and users are continuing to expect more value and flexibility in electric vehicle motor and control systems as they are applied today. In order to respond to these market demands, traction system designers have been forced to develop new approaches to reduce cost and improve functions and features of the overall system. Development is being done in a multi-generational format that allows the market to take advantage of today's technology, while looking forward to new advances on the horizon. Flight Systems has introduced a second generation system using separately excited DC shunt wound motors. The separately excited DC motor system offers many of the features that are generally found on the advanced AC systems. Historically, most electric vehicles have relied on series motor designs because of their ability to produce very high levels of torque at low speeds. But, as the demand for high efficiency systems increases, i.e., systems that are more closely applied to customers' specific torque requirements, shunt motors are now often being considered over series motors. In most applications, by independently controlling the field and armature currents in the separately excited motor, the best attributes of both the series and the shunt wound motors can be combined.

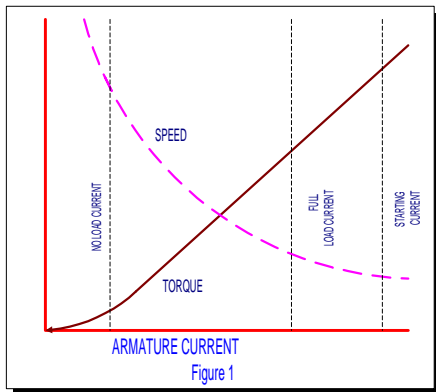

As shown in the typical performance curves of Figure 1, the high torque at low speed characteristic of the series motor is evident.

In a shunt motor, the field is connected directly across the voltage source and is therefore independent of variations in load and armature current. If field strength is held constant, the torque developed will vary directly with the armature current. If the mechanical load on the motor increases, the motor

slows down, reducing the back EMF (which depends on the speed, as well as the constant field strength). The reduced back EMF allows the armature current to increase, providing the greater torque needed to drive the increased mechanical load. If the mechanical load is decreased, the process reverses. The motor speed and the back EMF increase, while the armature current and the torque developed decrease. Thus, whenever the load changes, the speed changes also, until the motor is again in electrical balance.

In a shunt motor, the variation of speed from no load to normal full load on level ground is less than 10%. For this reason, shunt motors are considered to be constant speed motors (Figure 2).

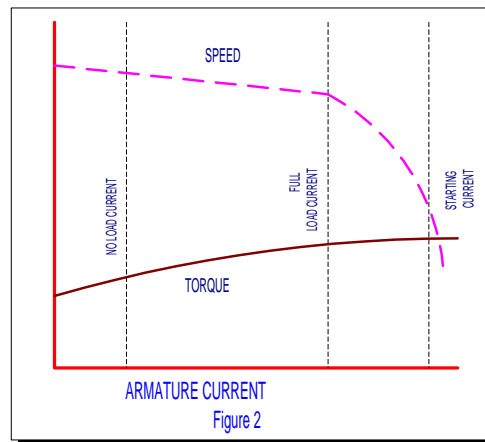

In the separately excited motor, the motor is operated as a fixed field shunt motor in the normal running range. However, when additional torque is required, for example, to climb non-level terrain, such as ramps and the like, the field current is increased to provide the higher level of torque. In most cases, the armature to field ampere turn ratio can be very similar to that of a comparable size series motor (Figure 3.)

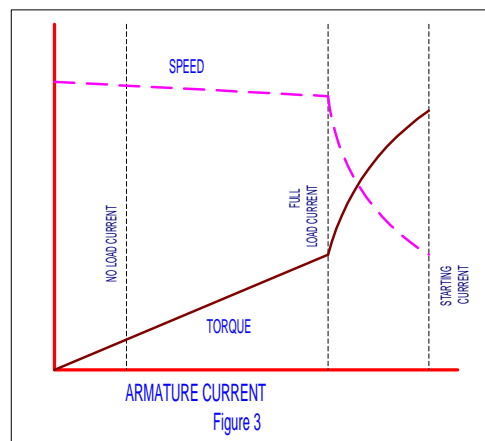

Aside from the constant horsepower characteristics described above, there are many other features that provide increased performance and lower cost. The following description provides a brief introduction to some of these features.

Section 1. 2 Solid-State Reversing

The direction of armature rotation on a shunt motor is determined by the direction in which current flows through the field windings. Because of the shunt motor field, typically only requires about 10% of the armature current at full torque, it is normally cost effective to replace the double-pole, double-throw reversing contactor with a low power transistor H-Bridge circuit (Figure 4).

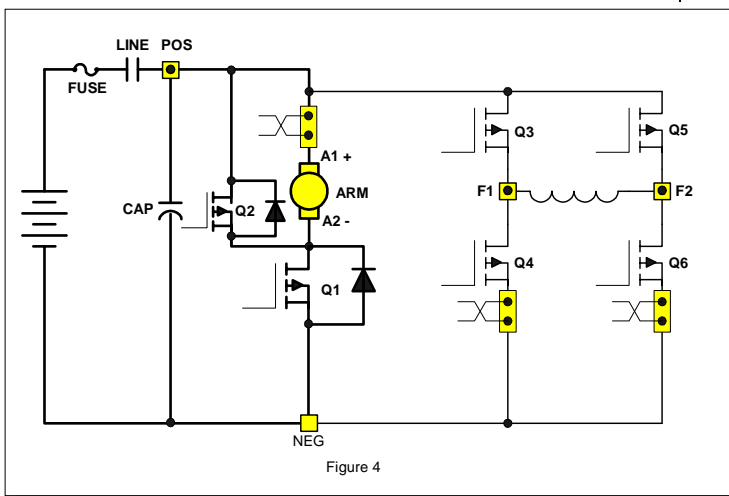

Figure 4

By energizing the transistors in pairs, current can be made to flow in either direction in the field. The field and armature control circuits typically operate at 12KHZ to 15KHZ, a frequency range normally above human hearing. This high frequency, coupled with the elimination of directional contactors, provides for very quiet vehicle operation.

The line contactor is normally the only contactor required for the shunt motor traction circuit. This contactor is used for both pre-charge of the line capacitors and for emergency shut down of the motor circuit, in case of problems that would cause a full motor torque condition. The line can be energized and de-energized by the various logic combinations of the vehicle, i.e. activate on key, seat or start switch closure, and de-energize on time out of idle vehicle. Again, these options add to the quiet operation of the vehicle.

Section 1. 3 Flexible System Application

Because the shunt motor controller has the ability to control both the armature and field circuits independently, the system can normally be adjusted

for maximum system efficiencies at certain operating parameters. Generally speaking, with the ability to independently control the field and armature, the motor performance curve can be maximized through proper control application.

Section 1. 4 More Features with Fewer Components

Field weakening with a series wound motor is accomplished by placing a resistor in parallel with the field winding of the motor. Bypassing some of the current flowing in the field into the resistor causes the field current to be less, or weakened. With the field weakened, the motor speed will increase, giving the effect of "overdrive". To change the "overdrive speed", it is necessary to change the resistor value. In a separately excited motor, independent control of the field current provides for infinite adjustments of "overdrive" levels, between the motor base speed and maximum weak field. The desirability of this feature is enhanced by the elimination of the contactor and resistor required for field weakening with a series motor.

With a separately excited motor, overhauling speed limit, or downhill speed, will also be more constant. By its nature, the shunt motor will try to maintain a constant speed downhill. This characteristic can be enhanced by increasing the field strength with the control. Overhauling load control works in just the opposite way of field weakening, as armature rotation slows with the increase of current in the field. An extension of this feature is a zero-speed detect feature which prevents the vehicle from free-wheeling down an incline, should the operator neglect to set the brake.

Regenerative braking (braking energy returned to the battery) may be accomplished completely with solid-state technology. The main advantage of regenerative braking is increased motor life. Motor current is reduced by 50% or better during braking while maintaining the same braking torque as electrical braking with a diode clamp around the armature. The lower current translates into longer brush life and reduced motor heating. Solid state regenerative braking also eliminates a power diode, current sensor and contactor from the circuit.

For Flight Systems, the future is now, as we make available a new generation of electric traction motor systems for electric vehicles having separately excited DC shunt motors and controls. Features that were once thought to be only available on future AC or brushless DC technology vehicles systems are now achievable and affordable.

Section 2. FEATURES OF SX FAMILY OF TRANSISTOR MOTOR CONTROLLERS

Section 2.1 Performance

Section 2.1.1 Oscillator Card Features

Section 2.1.1.a Standard Operation

The oscillator section of the card has two adjustable features, creep speed and minimum field current. The creep speed can be adjusted by Function 2 of the handset. The field control section allows the adjustment of the field weakening level in order to set the top speed of the motor. This top speed function (Minimum Field Current) is enabled when the armature current is less than the value set by Function 24. Top Speed can be adjusted by Function 7 of the handset .

The % ON-time has a range of approximately 0 to 100 percent. The SX controllers operate at a constant frequency and the % ON-time is controlled by the pulse width of the voltage/current applied to the motor circuits.

Section 2.1.1.b Control Acceleration

This feature allows for adjustment of the rate of time it takes for the control to accelerate to 100% applied battery voltage to the motor on hard acceleration. Armature C/A is adjusted by Function 3 from 0.1 to 22 seconds.

Section 2.1.2 Current Limit

This circuit monitors motor current by utilizing sensors in series with the armature and field windings. The information detected by the sensor is fed back to the card so that current may be limited to a preset value. If heavy load currents are detected, this circuit overrides the oscillator and limits the average current to a value set by Function 4 and Function 8 of the Handset. The C/L setting is based on the maximum thermal rating of the control. Because of the flyback current through 3REC, the motor current is usually greater than battery current, except at 100% ON time.

Section 2.1.3 Regenerative Braking to Zero Speed

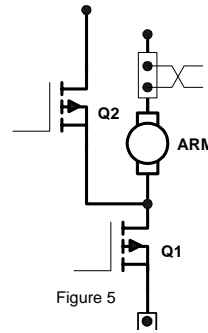

Figure 5). Armature current is regulated to the regen current limit as set by Function 9. As the vehicle slows down, the field current continues to increase, and transistor Q2 begins to chop. The field current will increase until it reaches a preset value set by Function 10, and transistor Q2 on-time will increase until it reaches 100% on-time. Once both of the above conditions have been met, and regen current limit can no longer be maintained, the braking function is canceled. Part of the energy produced by the motor during regen is returned to the battery, and part is dumped in the motor as heat.

Section 2.1.4 Auxiliary Speed Control

Section 2.1.4.a Field Weakening

This function allows the adjustment of the field weakening level in order to set the top speed of the motor. The function is enabled when the armature current is less than the value set by Function 24 and the accelerator input voltage is greater than 2.9 volts. It is important to note that this function is used to optimize motor and control performance, and this setting will be determined by Flight Systems and OEM engineers at the time of vehicle development. *This setting must not be changed by field personnel without the permission of the OEM.*

Section 2.1.4.b Speed Limits

This feature provides a means to control speed by limiting motor volts utilizing "adjustable speed limits", initiated by individual limit switches. The NC switches are connected between input points on the control card and battery positive. The lower motor volt limit always takes priority when more than one switch input is open. This motor volt limit regulates top speed of the transistor controller, but actual vehicle speed will vary at any set point depending on the loading of the vehicle.

Section 2.1.4.c Top Speed Regulation

This feature requires a system tachometer. The standard Flight Systems system tach is built into the motor and provides four pulses per armature

revolution. Once the control has been calibrated to the vehicle parameters (gear ratio and wheel rolling radius), using Function 1, speed can be measured with a resolution of +/- 1 mph. When traveling down an incline, if the vehicle speed increases to the overspeed setting, the control automatically transitions to the regen mode. The maximum incline on which the control will be able to maintain regulation is determined by the characteristics of the motor, the maximum regen armature current limit setting (Function 9), and the maximum regen field current limit setting (Function 10).

When the vehicle reaches the bottom of the incline, and the vehicle speed decreases below the overspeed setting on the level surface, the control automatically transitions back to the normal running mode.

Section 2.1.5 Ramp Start

This feature provides maximum control torque to restart a vehicle on an incline. The memory for this function is the directional switch. When stopping on an incline, the directional switch must be left in its original or neutral position to allow the control to initiate full power when restarted. The accelerator potentiometer input will modulate ramp start current.

Section 2.1.6 On-Board Coil Drivers and Internal Coil Suppression

A coil driver for the LINE contactor is on-board the control card. This contactor must have a coil rated for the vehicle battery volts.

Section 2.2 System Protective Override

Section 2.2.1 Static Return to Off (SRO)

This inherent safety feature of the control is designed to prevent the driver from starting the vehicle with the accelerator pedal depressed. If the pedal is depressed when the key is turned on, the control will not operate until the accelerator pedal is no longer depressed.

Section 2.2.2 Accelerator Volts Hold Off

This feature checks the voltage level at the accelerator input whenever the key switch is activated. If, at start-up, the voltage is greater than 0.9 volts, the control will not operate. This feature assures that the control is calling for low speed operation at start up.

Section 2.2.3 Pulse Monitor Trip (PMT)

The PMT design contains three features which shut down, or lock out, control operation if a fault conditions occurs that would cause a disruption of normal vehicle operation:

- Look ahead
- Look again
- Automatic look again and reset

The PMT circuit will not allow the control to start under the following conditions:

- The control monitors both armature and field FET's at start-up and during running.
- The control will not allow the line contactor to close at start-up, or will drop it out during running, if either the armature or field FET's are defective, so as to cause uncontrolled truck movement.

Section 2.2.4 Thermal Protector (TP)

This temperature sensitive device is internal to the power transistor (Q1) module. If the transistor's temperature begins to exceed the design limits, the thermal protector will lower the maximum current limit, and maintain the transistors within their temperature limits. As the control cools, the thermal protector will automatically reset, returning the control to full power.

Section 2.2.5 Low Voltage

Batteries under load, particularly if undersized or more than 80 percent discharged, will produce low voltages at the control terminals. The SX control is designed for use down to 50 percent of a nominal battery voltage of 36-84 volts, and 75 percent of a nominal battery voltage of 24 volts. Lower battery voltage may cause the control to operate improperly, however, the resulting PMT should open the Line contactor, in the event of a failure.

Section 2.3 Diagnostics

The control detects the system's present operating status and this status can be displayed to either the Dash Display or the Handset.

Section 2.3.1 Status Codes

Section 2.3.1a Standard Status Codes

The SX control has a wide variety of Status Codes that assist the service technician and operator in trouble shooting the vehicle. If mis-operation of the vehicle occurs, a status code will be displayed on the Dash Display for vehicles so equipped, or be

available from the status code displayed when the Handset is plugged into the "Y" plug of the logic card.

With the status code number, follow the procedures outlined in DIAGNOSTIC STATUS CODES to determine the problem and appropriate corrective action.

Note: The Status Code Instruction Sheets do not purport to cover all possible causes of a display of a "status code ". They do provide instructions for checking the most direct inputs that can cause status codes to appear.

Section 2.3.1.b Stored Status Codes

This feature records the last 16 "Stored Status Codes" that have caused a PMT controller shut down and/or disrupted normal vehicle operation. (PMT type faults are reset by cycling the key switch). These status codes, along with the corresponding BDI and hourmeter readings, can be accessed with the Handset, or by using the RS 232 communications port and dumping the information to a Personal Computer terminal.

Section 2.3.2 Odometer Readings

This feature will transmit the miles of use of the traction control to the Dash Display.

Section 2.3.3 RS 232 Communication Port

This serial communication port can be used with Interactive Custom Dash Displays to allow changes to vehicle operating parameters by the operator. Or, it

can be used by service personnel to dump control operating information and settings into a personal computer program.

Section 2.3.4 Circuit Board Coil Driver Modules

A Coil driver is internal to the control card, and is the power device that operates the Line contactor coil. On command from the control card, these drivers initiate opening and closing the contactor coils. All driver modules are equipped with reverse battery protection, such that, if the battery is connected incorrectly, the contactors can not be closed electrically.

Section 3.0 ORDERING INFORMATION, ELEMENTARY AND OUTLINE DRAWINGS

Section 3.1 Ordering Information for Separately Excited Controls

Example:

Part Number: **51 – FX** **50** **3** **GXXX**
Argument Number: 01 02 03 04 05

Argument 01: Basic Electric Vehicle Control Number

Argument 02: Control Type:
FX = Separately Excited Control

Argument 03: Armature Current:
30 = 300 amps
50 = 500 amps

Argument 04: Field Current:
2 = 20 amps
3 = 30 amps

Argument 05: Application Number:
(4 characters)
G014 = Club Car Regen 1 or 2, 48 Volt, Upgrade Speed Motor
G015 = Club Car IQ, 48 Volt, Upgrade Speed Motor
G016 = Club Car IQ, 48 Volt, Upgrade Torque Motor
G017 = Yamaha G19, G22, or Drive, 48 Volt, Upgrade Speed Motor
G018 = EZGo DCS, 36 Volt, Upgrade Motor
G019 = EZGo PDS, 36 Volt, Upgrade Motor
G020 = Club Car Regen 2, 48 Volt, Stock Motor
G021 = Club Car IQ, 48 Volt, Stock Motor
G022 = Yamaha G19 or G22, 48 Volt, Stock motor
G023 = EZGo DCS, 36 Volt, Stock Motor
G024 = EZGo PDS, 36 Volt, Stock Motor
G025 = EZGo DCS, 48 Volt, Stock motor
G026 = EZGo PDS, 48 Volt, Stock Motor
G027 = Yamaha Drive, 48 Volt, Stock Motor
G028 = Yamaha Drive, 48 Volt, Upgrade Motor

NOTE: Application numbers that reference an upgrade motor are GE motors.
If application is not listed above call the factory for assistance.

Section 3.2 Outline: Package Size

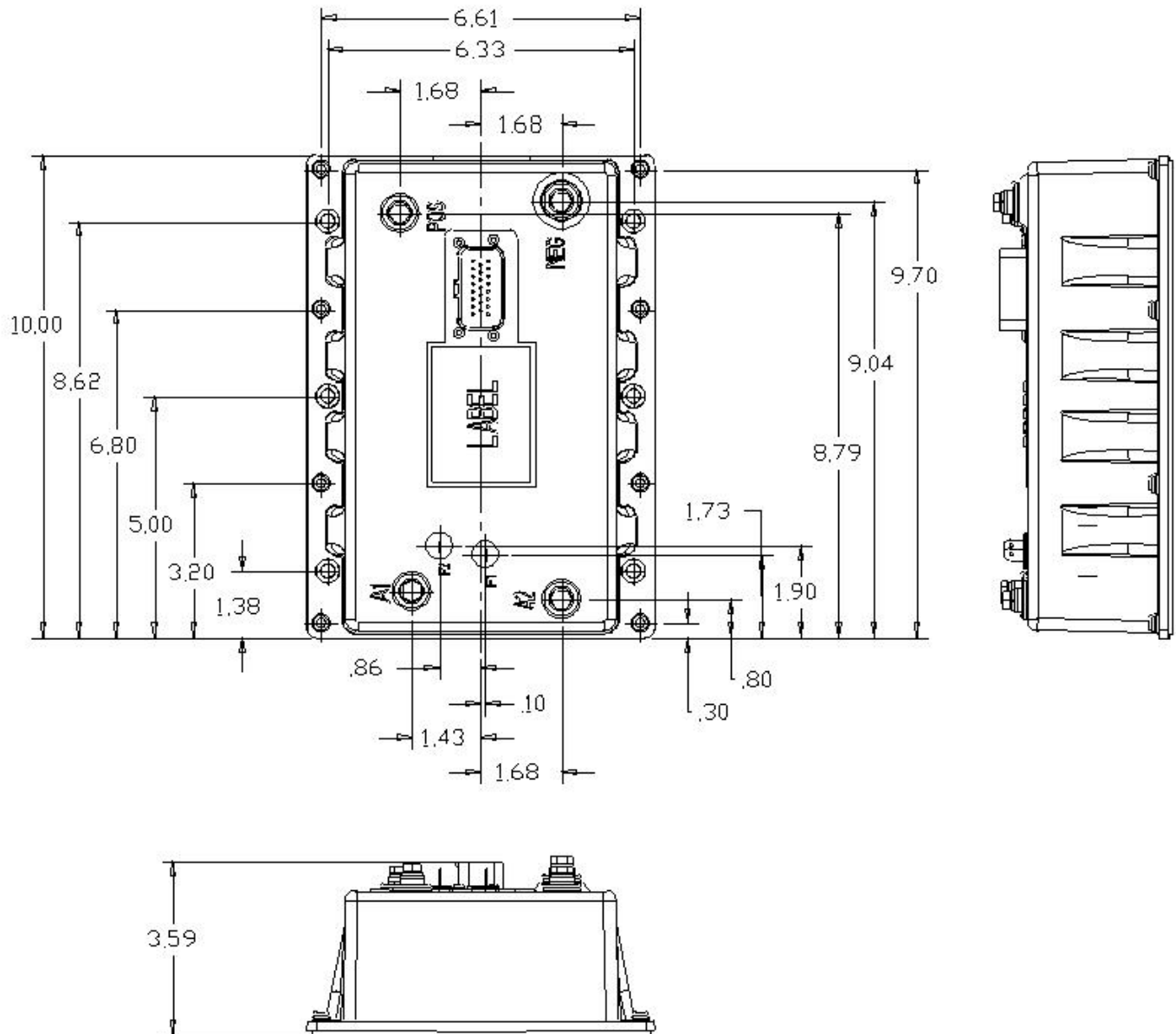

Section 3.3 Standard Elementary for Neighborhood Electric Vehicle Application

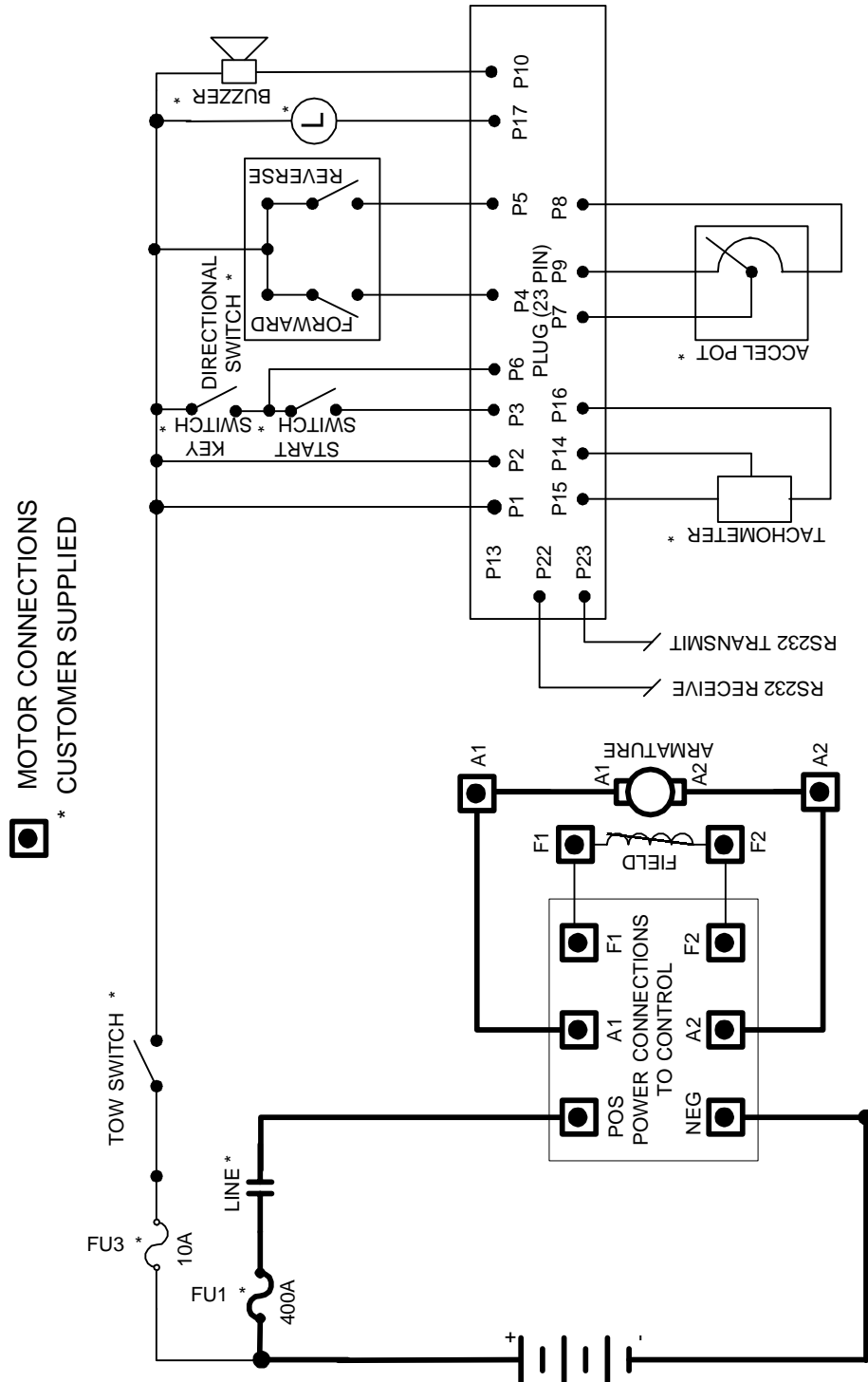

Section 3.4 Neighborhood Electric Vehicle Application Input/Output List

PIN	MAIN PLUG INPUT/OUTPUT DESCRIPTION
1	BATTERY VOLTS FROM TOW SWITCH
2	BATTERY VOLTS FROM TOW SWITCH
3	BATTERY VOLTS FROM ACCELERATOR START SWITCH
4	BATTERY VOLTS FROM FORWARD SWITCH
5	BATTERY VOLTS FROM REVERSE SWITCH
6	BATTERY VOLTS FROM KEY SWITCH
7	ACCELERATOR INPUT VOLTAGE SIGNAL
8	ACCELERATOR NEGATIVE
9	ACCELERATOR POT +5 VOLTS SUPPLY (3 WIRE POT)
10	BACK UP ALARM AND ZERO SPEED DETECT ALARM
11	Not Used
12	N/A
13	RS232/IrDa SWITCH
14	TACHOMETER INPUT SIGNAL
15	TACHOMETER 12 VOLT OUTPUT
16	NEGATIVE FOR TACH
17	LINE CONTACTOR COIL DRIVER
18	Not Used
19	Not Used
20	Not Used
21	Not Used
22	SERIAL RECEIVE
23	SERIAL TRANSMIT

Connections to Main Plug (23 Pin)

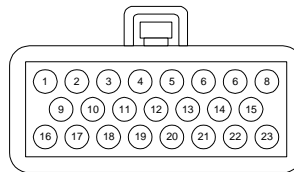

WIRE END VIEW - MAIN PLUG

Section 4.0 TROUBLESHOOTING AND DIAGNOSTIC STATUS CODES

Section 4.1 General Maintenance Instructions

The transistor control, like all electrical apparatus, does have some thermal losses. The semiconductor junctions have finite *temperature* limits, above which these devices may be damaged. For these reasons, normal maintenance should guard against any action which will expose the components to excessive heat and/or those conditions which will reduce the heat dissipating ability of the control, such as restricting air flow.

The following Do's and Don't's should be observed:

Any controls that will be applied in ambient temperatures over 100° F (40° C) should be brought to the attention of the vehicle manufacturer.

All external components having inductive coils must be filtered. Refer to vehicle manufacturer for specifications.

The wiring should not be directly steam cleaned. In dusty areas, blow low-pressure air over the control to remove dust. In oily or greasy areas, a mild solution of detergent or denatured alcohol can be used to wash the control, and then low-pressure air should be used to completely dry the control.

For the control to be most effective, it must be mounted against the frame of the vehicle. The metal vehicle frame, acting as an additional heat sink, will give improved vehicle performance by keeping the control package cooler. *Apply a thin layer of heat-transfer grease (such as Dow Corning 340) between the control heat sink and the vehicle frame.*

Control wire plugs and other exposed transistor control parts should be kept free of dirt and paint that might change the effective resistance between points.

CAUTION: The vehicle should not be plugged when the vehicle is jacked up and the drive wheels are in a free wheeling position. The higher motor speeds can create excessive voltages that can be harmful to the control.

Do not hipot (or megger) the control. Refer to control manufacturer before hipotting.

Use a lead-acid battery with the voltage and ampere hour rating specified for the vehicle. Follow normal battery maintenance procedures, recharging before

80 percent discharged with periodic equalizing charges.

Visual inspection of Flight Systems contactors contained in the traction and pump systems is recommended to occur during every 1000 hours of vehicle operation. Inspection is recommended to verify that the contactors are not binding and that the tips are intact and free of contaminants.

Flight Systems does not recommend that any type of welding be performed on the vehicle after the installation of the control(s) in the vehicle. Flight Systems will not honor control failures during the warranty period when such failures are attributed to welding while the control is installed in the vehicle.

Section 4.2 Cable Routing and Separation

Electrical noise from cabling of various voltage levels can interfere with a microprocessor-based control system. To reduce this interference, Flight Systems recommends specific cable separation and routing practices, consistent with industry standards.

Section 4.2.1 Application Responsibility

The customer and customer's representative are responsible for the mechanical and environmental locations of cables. They are also responsible for applying the level rules and cabling practices defined in this section.

To help ensure a lower cost, noise-free installation, Flight Systems recommends early planning of cable routing that complies with these level separation rules.

On new installations, sufficient space should be allowed to efficiently arrange mechanical and electrical equipment.

On vehicle retrofits, level rules should be considered during the planning stages to help ensure correct application and a more trouble-free installation.

Section 4.2.2. Signal/Power Level Definitions

The signal/power carrying cables are categorized into four defining levels: low, high, medium power, and high power. Within those levels, signals can be further divided into classes.

Sections 4.2.2.a through 4.2.2.d define these levels and classes, with specific examples of each. Section 4.2.3 contains recommendations for separating the levels.

4.2.2.a Low-Level Signals (Level L)

Low-level signals are designated as *level L*. These consist of:

- Analog signals 0 through ± 15 V
- Digital signals whose logic levels are less than 15 V DC
- 4 – 20 mA current loops
- DC busses less than 15 V and 250 mA

The following are specific examples of level L signals used in drive equipment cabling:

- Control common tie
- DC busses feeding sensitive analog or digital hardware
- All wiring connected to components associated with sensitive analog hardware with less than 5V signals (for example, potentiometers and tachometers)
- Digital tachometers and resolvers
- Dash display cabling
- RS-232 cabling

Note: Signal inputs to analog and digital blocks should be run as shielded twisted-pair (for example, inputs from tachometers, potentiometers, and dash displays).

4.2.2.b High-Level Signals (Level H)

High-level signals are designated as *level H*. These signals consist of:

- Analog and digital signals greater than 15 V DC and less than 250 mA

For example, switch inputs connected to battery volts are examples of level H signals used in drive equipment cabling.

4.2.2.c Medium-Power Signals (Level MP)

Medium power signals are designated as *level MP*. These signals consist of:

- DC switching signals greater than 15 V
- Signals with currents greater than 250 mA and less than 10A

The following are specific examples of level MP signals used in drive equipment cabling:

- DC busses less than 10 A
- Contactor coils less than 10 A
- Machine fields less than 10 A

4.2.2.d. High Power Signals (Level HP)

Power wiring is designated as *level HP*. This consists of DC busses and motor wiring with currents greater than 10 A.

The following are specific examples of level HP signals used in drive equipment cabling:

- Motor armature loops
- DC outputs 10 A and above
- Motor field loops 10 A and above

4.2.3. Cable Spacing Guidelines

Recommended spacing (or clearance) between cables (or wires) is dependent on the level of the wiring inside them. For correct level separation when installing cable, the customer must apply the **general guidelines** (section 4.2.3.a), outlined below.

4.2.3.a General Cable Spacing

The following general practices should be used for *all levels* of cabling:

- All cables and wires of like signal levels and power levels must be grouped together.
- In general, different levels must run in separate wire bundles, as defined in the different classes, identified above. Intermixing cannot be allowed, unless noted by exception.
- Interconnecting wire runs should carry a level designation.
- If wires are the same level and same type signal, group those wires from one location to any other location together in multiconductor cables or bind them together with twine or zip-ties.
- When unlike signals must cross, cross them in 90° angles at a maximum spacing. Where it is not possible to maintain spacing, place a grounded steel barrier between unlike levels at the crossover point.

4.2.4 Cabling for Vehicle Retrofits

Reducing electrical noise on vehicle retrofits requires careful planning. Lower and higher levels should never encircle each other or run parallel for long distances.

It is practical to use existing wire runs or trays as long as the level spacing (see section 4.2.2) can be maintained for the full length of the run.

Existing cables are generally of high voltage potential and noise producing. Therefore, route levels L and H in a path separate from existing cables, whenever possible.

For level L wiring, use barriers in existing wire runs to minimize noise potential.

Do not loop level L signal wires around level H, level MP, or HP wires.

4.2.5 RF Interference

To prevent radio frequency (RF) interference, care should be taken in routing power cables in the vicinity of radio-controlled devices.

Section 4.2.6 Suppression

Unless specifically noted otherwise, suppression (for example, a snubber) is required on all inductive devices controlled by an output. This suppression minimizes noise and prevents damage caused by electrical surges.

Section 4.3 Recommended Lubrication of Pins and Sockets Prior to Installation

Beginning in January of 1999, Flight Systems implemented the addition of a lubricant to all connections using pins and sockets on EV100/EV200 and Gen II products. Any connection made by Flight Systems to the A, B, X, Y, or Z plugs, includes the lubricant NYE 760G to prevent fretting of these connections during vehicle operation.

Fretting occurs during microscopic movement at the contact points of the connection. This movement exposes the base metal of the connector pin which, when oxygen is present, allows oxidation to occur. Sufficient build up of the oxidation can cause intermittent contact and intermittent vehicle operation. This can occur at any similar type of connection, whether at the control or in any associated vehicle wiring, and the resultant intermittent contact can provide the same fault indication as actual component failure.

The addition of the NYE 760G lubricant will prevent the oxidation process by eliminating the access of oxygen to the contact point. Flight Systems recommends the addition of this lubricant to the 12 pin and 23 pin plugs of all new Gen II controls at the time of their installation into a vehicle

When servicing existing vehicles exhibiting symptoms of intermittent mis-operation or shutdown by the Flight Systems control, Flight Systems recommends the addition of this lubricant to all 12 and 23 pin plugs, after proper cleaning of the connectors, as a preventative measure to insure fretting is not an issue before Flight Systems control replacement. Also, for long term reliable control

operation, the plug terminals must be maintained per these instructions with the recommended contact cleaner and lubricant which provides a high degree of environmental and fretting protection.

New and re-manufactured control plugs are cleaned and lubricated prior to shipment from the factory. However, in applications where severe vibration or high temperature cycling and excessive humidity (such as freezers) are present, it is recommended that the plug terminals be cleaned and lubricated every year, per this instruction. In normal applications, plug maintenance should be performed every two years, unless intermittent problems arise with the plugs, requiring more immediate attention.

Warning: Do not use any other cleaners or lubricants other than the ones specified.

WARNING: Before conducting maintenance on the vehicle, jack up the drive wheels, disconnect the battery and discharge the capacitors. Consult the Operation and Service Manual for your particular vehicle for details on discharging the capacitors; this procedure differs between SCR and Transistor controls.

1. **Disconnect** plug from controller or mating plug.
2. **Locate** the plug that contains the socket (female) terminals. *Maintenance needs only to be performed on the plug containing the socket (female) type terminals. Reconnecting the plugs will lubricate the pin (male) terminals.*
3. **Clean** each terminal using Chemtronics® contact cleaner "Pow-R-Wash CZ" as shown in Figure 1.

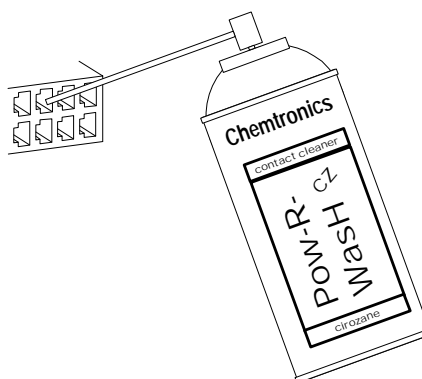

Figure 1

4. **Lubricate** each terminal using Nye® 760G lubricant as shown in figure 2. Apply enough lubricant to each terminal opening to completely fill each opening to a depth of .125" maximum.

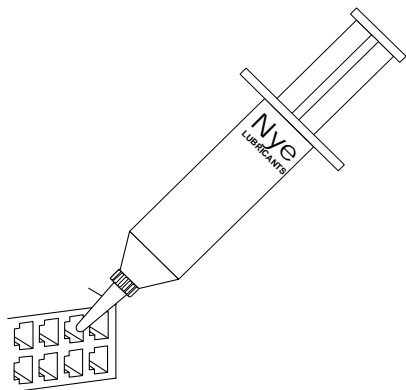

Figure 2

5. **Reconnect** plugs.

Reference

Cleaner	Chemtronics® Pow-R-Wash CZ Contact Cleaner
Lubricant	Nye® Lubricants NYOFlight SystemsL® 760G
Flight Systems Plug Lub Kit	Contains both above products: 328A1777G1

Section 4.4 General Troubleshooting Instructions

Trouble-shooting the ZX family of controls should be quick and easy when following the instructions outlined in the following status code instruction sheets.

If mis-operation of the vehicle occurs, a status code will be displayed on the Dash Display (for vehicles equipped with a Dash Display) or made available by

plugging a Handset into the plug "Y" location, and then reading the status code.

With the status code number, follow the procedures outlined in the status code instruction sheets to determine the problem.

Important Note: Due to the interaction of the logic card with all vehicle functions, almost any status code or control fault could be caused by the logic card. After all other status code procedures have been followed and no problem is found, the controller should then be replaced as the last option to correct the problem.

The same device designations have been maintained on different controls but the wire numbers may vary. Refer to the elementary and wiring diagrams for your specific control. The wire numbers shown on the elementary diagram will have identical numbers on the corresponding wiring diagrams for a specific vehicle, but these numbers may be different from the numbers referenced in this publication.

WARNING: Before trouble-shooting, jack up the drive wheels, disconnect the battery and discharge the capacitors. Reconnect the battery as needed for specific checks. Capacitors should be discharged by connecting a 200 ohm 2 watt resistor between the positive and negative terminals on the control panel.

Check resistance on R x 1000 scale from frame to power and control terminals. A resistance of less than 20,000 ohms can cause misleading symptoms. Resistance less than 1000 ohms should be corrected first.

Before proceeding, visually check for loose wiring, mis-aligned linkage to the accelerator switch, signs of overheating of components, etc.

Tools and test equipment required are: clip leads, volt-ohm meter (20,000 ohms per volt) and basic hand tools.

Section 4.5 Traction Control Codes

TRACTION STATUS CODE	DESCRIPTION OF STATUS	CAUSE OF STATUS INDICATION
-05	Start switch fails to close.	This status code will be displayed when the accelerator voltage at P7 is >1.4V, with the start switch open (P3 > 2.5 volts)
MEMORY RECALL NO	CORRECTIVE ACTIONS	TROUBLE-SHOOTING DIAGRAM
Circuits valid for Traction Controller	<p>SYMPTOM Control will not operate.</p> <p>POSSIBLE CAUSE Defective start switch circuit.</p> <ul style="list-style-type: none"> • Check start switch to insure closure when accelerator pedal is depressed. • Check for open circuit or loose connections in start switch wiring. • Check for proper accelerator pot adjustment <p>Defective accelerator switch.</p> <ul style="list-style-type: none"> • Check accelerator switch potentiometer for proper operation and ohmic value 	

TRACTION STATUS CODE	DESCRIPTION OF STATUS	CAUSE OF STATUS INDICATION
-06	The accelerator pedal is depressed with no direction selected.	This status code will be displayed when the accelerator voltage, at P7>1.4V, and no direction is selected (P4 and P5 are both less than 50% of battery volts)
MEMORY RECALL NO	CORRECTIVE ACTIONS	TROUBLE-SHOOTING DIAGRAM
Circuits valid for Traction Controller	<p>SYMPTOM Control will not operate.</p> <p>POSSIBLE CAUSE Accelerator pedal is depressed before closing forward or reverse directional switch.</p> <ul style="list-style-type: none"> • Status code will disappear when directional switch is closed or when accelerator pedal is released. <p>Defective directional switch</p> <ul style="list-style-type: none"> • Check forward or reverse switch to insure closure when direction is selected. <p>Open circuit between directional switch(es) and battery positive or between directional switch(es) and P4 or P5.</p> <ul style="list-style-type: none"> • Check all control wires and connections shown in trouble shooting diagram. 	

INSTALLATION AND OPERATION

SX TRANSISTOR CONTROL

TRACTION STATUS CODE	DESCRIPTION OF STATUS	CAUSE OF STATUS INDICATION
-08	Accelerator voltage input is too high on power up after initial key switch closure.	This status code will be displayed when the accelerator input voltage at P7 >0.9V when the battery plug or key switch is opened and closed.
MEMORY RECALL NO	CORRECTIVE ACTIONS	TROUBLE-SHOOTING DIAGRAM
Circuits valid for Traction Controller	<p>SYMPTOM Control will not operate</p> <p>POSSIBLE CAUSE Accelerator input is mis-adjusted or defective.</p> <ul style="list-style-type: none"> Input voltage at P7 should be less than 0.9 volts. Adjust or replace accelerator unit to insure that the voltage at P7 is less than 0.9 volts before depressing pedal. <p>Open circuit at P8 or open potentiometer wiper at P7 – verify continuity of wiring at both points.</p>	

TRACTION STATUS CODE	DESCRIPTION OF STATUS	CAUSE OF STATUS INDICATION
-09	Both the forward and reverse switches or the turf and reverse switches are closed at the same time.	This status code will be displayed when P4 and P5 or P6 and P5 are greater than 50% of battery volts.
MEMORY RECALL NO	CORRECTIVE ACTIONS	TROUBLE-SHOOTING DIAGRAM
Circuits valid for Traction Controller	<p>SYMPTOM Control will not operate.</p> <p>POSSIBLE CAUSE Forward or reverse or turf switch welded closed or mis-adjusted to be held closed.</p> <ul style="list-style-type: none"> Replace or adjust directional switches to insure that they are open when switch is returned to neutral or off. <p>Short circuit between battery positive and P4,P5 and/or P6.</p> <ul style="list-style-type: none"> Disconnect wires from P4, P6 and P5 and check wire for short circuit to positive side of directional switch <p>Defective control.</p> <ul style="list-style-type: none"> Disconnect wires and measure voltage at P4, P6 and P5. Voltage should be less than 50% of battery volts, if not, replace control. 	

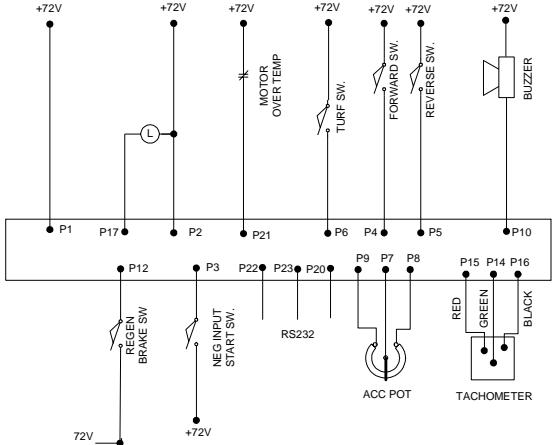
TRACTION STATUS CODE	DESCRIPTION OF STATUS	CAUSE OF STATUS INDICATION
-11	Start switch closed on power up after initial key switch closure.	This status code will be displayed when P3 is less than 2.5 volts when the key switch is closed.
MEMORY RECALL NO	CORRECTIVE ACTIONS	<u>TROUBLE-SHOOTING DIAGRAM</u>
Circuits valid for Traction Controller	<p><u>SYMPTOM</u> Control will not operate.</p> <p><u>POSSIBLE CAUSE</u> Start switch is mis-adjusted or defective.</p> <ul style="list-style-type: none"> Input voltage at P3 should be greater than 2.5 volts at key switch closure. Adjust or replace accelerator unit to insure that the voltage at P3 greater than 2.5 volts before closing the start switch. <p>Short circuit between battery negative and P3 in start switch input circuit.</p> <ul style="list-style-type: none"> Disconnect wire from P3. Check for short circuit from this wire to battery negative. Resistance should be greater than 20K ohms. <p>Defective control.</p> <ul style="list-style-type: none"> Disconnect wire from P3. Measure voltage from P3 to negative. Voltage should be 2.5 to 5.0 volts. If not, replace the control. 	

TRACTION STATUS CODE	DESCRIPTION OF STATUS	CAUSE OF STATUS INDICATION
-14	Rolling Radius or Gear Ratio or Top Speed parameters are out of limits for the motor.	This status code will be displayed when the Rolling Radius or Gear Ratio or Top Speed parameters are out of limits for the motor.
MEMORY RECALL NO	CORRECTIVE ACTIONS	<u>TROUBLE-SHOOTING DIAGRAM</u>
Circuits valid for Traction Controller	<p><u>SYMPTOM</u> Control will not operate.</p> <p><u>POSSIBLE CAUSE</u> Functions 13 , 16 or 21 is programmed to an incorrect value.</p> <p>Reprogram the above functions to the proper value and the status code should clear.</p>	<p>NO GRAPHIC FOR THIS STATUS CODE</p>

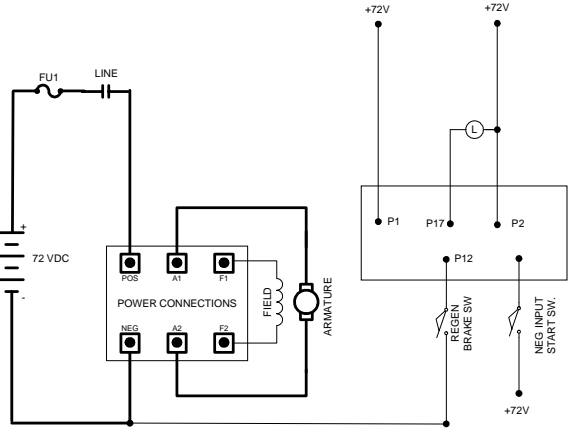
TRACTION STATUS CODE	DESCRIPTION OF STATUS	CAUSE OF STATUS INDICATION
-15	Battery voltage is too low at initial key switch closure.	This status code will be displayed when the battery volts are less than 68.3 volts at initial key switch on.
MEMORY RECALL NO	CORRECTIVE ACTIONS	<u>TROUBLE-SHOOTING DIAGRAM</u>
Circuits valid for Traction Controller	<p><u>SYMPTOM</u> Control will not operate.</p> <p><u>POSSIBLE CAUSE</u> Discharged battery</p> <ul style="list-style-type: none"> • Check battery voltage to confirm that it is a minimum of 68.3 volts. Charge battery, if required. <p>Defective battery</p> <ul style="list-style-type: none"> • Check each battery cell for proper voltage (greater than 1.95 volts at cell). Replace or repair battery. <p>Incorrect control card adjustment.</p> <ul style="list-style-type: none"> • Check Function 15 for proper adjustment for battery being used. See Handset instruction sheet for details. Adjust to proper settings. <p>Check "minimum" battery volts at P1 & NEG.</p>	

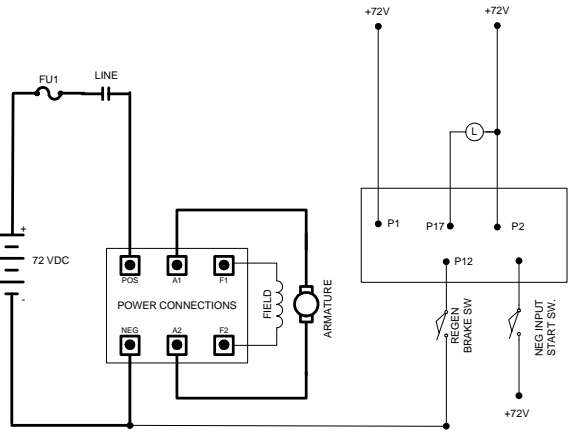
TRACTION STATUS CODE	DESCRIPTION OF STATUS	CAUSE OF STATUS INDICATION
-16	Battery voltage is too high at initial key switch closure.	This status code will be displayed when the battery volts are greater than 86 volts at initial key switch on.
MEMORY RECALL NO	CORRECTIVE ACTIONS	<u>TROUBLE-SHOOTING DIAGRAM</u>
Circuits valid for Traction Controller	<p><u>SYMPTOM</u> Control will not operate.</p> <p><u>POSSIBLE CAUSE</u> Discharged battery</p> <ul style="list-style-type: none"> • Check battery voltage to confirm that it is a minimum of 68.3 volts. Charge battery, if required. <p>Battery overcharged or incorrect battery used.</p> <ul style="list-style-type: none"> • Check each battery cell for proper voltage (maximum 2.4 volts per cell). If voltage is excessive, check battery charger for proper output voltage. <p>Incorrect control card adjustment.</p> <ul style="list-style-type: none"> • Check Function 15 for proper adjustment for battery being used. See Handset instruction sheet for details. Adjust to proper settings. <p>Check "maximum" battery volts at P1 & NEG.</p>	

TRACTION STATUS CODE	DESCRIPTION OF STATUS	CAUSE OF STATUS INDICATION
-21	Accelerator voltage is too high.	This status code will be displayed when the accelerator voltage at P7 is greater than 4.5 volts.
MEMORY RECALL NO	CORRECTIVE ACTIONS	<u>TROUBLE-SHOOTING DIAGRAM</u>
Circuits valid for Traction Controller	<p><u>SYMPTOM</u> Control will not operate.</p> <p><u>POSSIBLE CAUSE</u> Accelerator input is mis-adjusted or defective.</p> <ul style="list-style-type: none"> Input voltage at P7 should be less than 4.5 volts after initial key switch closure. Open wire exists between potentiometer negative and P8. Open wire exists between P7 and potentiometer wiper. 	

TRACTION STATUS CODE	DESCRIPTION OF STATUS	CAUSE OF STATUS INDICATION
-23	Motor field current is too high when the key switch is turned on.	This status code will be displayed when the current draw in the motor field is too high on start up.
MEMORY RECALL NO	CORRECTIVE ACTIONS	<u>TROUBLE-SHOOTING DIAGRAM</u>
Circuits valid for Traction Controller	<p><u>SYMPTOM</u> Control will not operate.</p> <p><u>POSSIBLE CAUSE</u> Defective control.</p> <ul style="list-style-type: none"> Replace controller unit. 	<p>NO GRAPHIC FOR THIS STATUS CODE</p>

TRACTION STATUS CODE	DESCRIPTION OF STATUS	CAUSE OF STATUS INDICATION
-24	Motor field current is too high when the key switch is turned on.	This status code will be displayed when the current draw in the motor field is too high on start up.
MEMORY RECALL NO	CORRECTIVE ACTIONS	<u>TROUBLE-SHOOTING DIAGRAM</u>
Circuits valid for Traction Controller	<p><u>SYMPTOM</u> Control will not operate.</p> <p><u>POSSIBLE CAUSE</u> Defective control.</p> <ul style="list-style-type: none"> • Replace controller unit. 	NO GRAPHIC FOR THIS STATUS CODE

TRACTION STATUS CODE	DESCRIPTION OF STATUS	CAUSE OF STATUS INDICATION
-27	12V buss is too low.	This status code will be displayed when the internal power supply of the control dips below 9.35V.
MEMORY RECALL YES	CORRECTIVE ACTIONS	<u>TROUBLE-SHOOTING DIAGRAM</u>
Circuits valid for Traction Controller	<p><u>SYMPTOM</u> Line contactor opens and closes and then can only be closed by opening and closing the key switch.</p> <p><u>POSSIBLE CAUSE</u> Discharged battery.</p> <ul style="list-style-type: none"> • Check battery to insure proper state of charge. Voltage may be dropping below 15V under load. <p>Loose connection at P1.</p> <ul style="list-style-type: none"> • Insure that the wire connection at P1 is tight. <p>Shorted Motor Tachometer</p> <ul style="list-style-type: none"> • Disconnect tach and run control, if status code 27 does not appear, check tach. <p>Defective control.</p> <ul style="list-style-type: none"> • Replace controller unit. 	<p>The diagram illustrates the electrical circuit for the 72VDC system. It starts with a 72VDC battery connected to a fuse (FU1) and a line input. The circuit then passes through a power connection block with terminals P08, A1, F1, NEG, A2, and F2. These terminals are connected to a motor's field and armature. Additionally, the circuit includes a control panel with terminals P1, P17, P2, and P12. A brake switch (BRAKE SW) and a negative input start switch (NEG INPUT START SW) are also shown, along with a lamp (L) connected to the +72V supply.</p>

TRACTION STATUS CODE	DESCRIPTION OF STATUS	CAUSE OF STATUS INDICATION
-41	Shorted thermal protector (TP) or transistor over temperature.	This status code will be displayed when the voltage at the thermal protector is too low.
MEMORY RECALL YES	CORRECTIVE ACTIONS	<u>TROUBLE-SHOOTING DIAGRAM</u>
Circuits valid for Traction Controller	<p><u>SYMPTOM</u> Reduced or no power to traction motor in control range.</p> <p><u>POSSIBLE CAUSE</u> Control is in thermal cut back.</p> <ul style="list-style-type: none"> Allow control to cool, status code should disappear. <p>Defective control.</p> <ul style="list-style-type: none"> Replace controller unit. (Values of less than 1.5 V at the thermal protector are typically indicative of a failed control.) <p><i>Flight Systems Sentry for Windows</i> software can be used to monitor control operation, and it will display a value for the thermal protector that is greater than 84 (corresponding to 1.65V), triggering this status code.</p>	

TRACTION STATUS CODE	DESCRIPTION OF STATUS	CAUSE OF STATUS INDICATION
-42	Motor armature offset voltage is too high.	This status code will be displayed when the value of motor amps is greater than 133 (corresponding to 2.7 volts) with no current flowing in the motor circuit.
MEMORY RECALL NO	CORRECTIVE ACTIONS	<u>TROUBLE-SHOOTING DIAGRAM</u>
Circuits valid for Traction Controller	<p><u>SYMPTOM</u> Control will not operate.</p> <p><u>POSSIBLE CAUSE</u> Defective control.</p> <ul style="list-style-type: none"> Replace controller unit. <p><i>Flight Systems Sentry for Windows</i> software can be used to monitor control operation, and it will display a value for the motor amps that is greater than 133, (corresponding to 2.6V), triggering this status code.</p>	

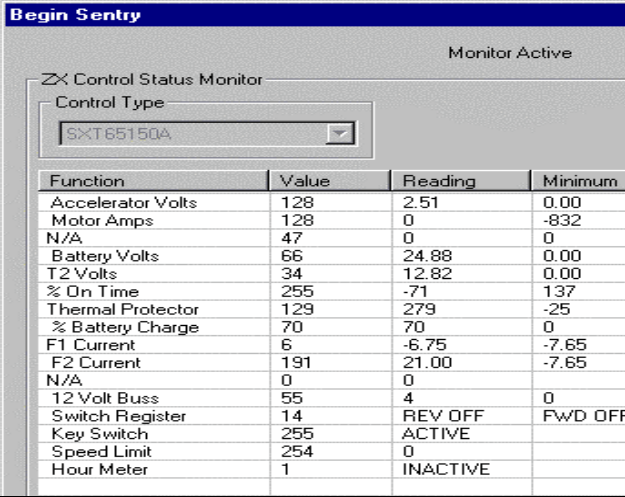
TRACTION STATUS CODE	DESCRIPTION OF STATUS	CAUSE OF STATUS INDICATION																																																																				
-43	Motor armature offset voltage is too low.	This status code will be displayed when the value of motor amps is less than 123 (corresponding to 2.4 volts) with no current flowing in the motor circuit.																																																																				
MEMORY RECALL NO	CORRECTIVE ACTIONS	<u>TROUBLE-SHOOTING DIAGRAM</u>																																																																				
Circuits valid for Traction Controller	<p><u>SYMPTOM</u> Control will not operate.</p> <p><u>POSSIBLE CAUSE</u> Defective control.</p> <ul style="list-style-type: none"> Replace controller unit. <p><i>Flight Systems Sentry for Windows software can be used to monitor control operation, and it will display a value for the motor amps that is less than 123 (corresponding to 2.4V), triggering this status code.</i></p>	 <table border="1"> <thead> <tr> <th>Function</th> <th>Value</th> <th>Reading</th> <th>Minimum</th> </tr> </thead> <tbody> <tr><td>Accelerator Volts</td><td>128</td><td>2.51</td><td>0.00</td></tr> <tr><td>Motor Amps</td><td>128</td><td>0</td><td>-832</td></tr> <tr><td>N/A</td><td>47</td><td>0</td><td>0</td></tr> <tr><td>Battery Volts</td><td>66</td><td>24.88</td><td>0.00</td></tr> <tr><td>T2 Volts</td><td>34</td><td>12.82</td><td>0.00</td></tr> <tr><td>% On Time</td><td>255</td><td>-71</td><td>137</td></tr> <tr><td>Thermal Protector</td><td>129</td><td>279</td><td>-25</td></tr> <tr><td>% Battery Charge</td><td>70</td><td>70</td><td>0</td></tr> <tr><td>F1 Current</td><td>6</td><td>-6.75</td><td>-7.65</td></tr> <tr><td>F2 Current</td><td>191</td><td>21.00</td><td>-7.65</td></tr> <tr><td>N/A</td><td>0</td><td>0</td><td></td></tr> <tr><td>12 Volt Buss</td><td>55</td><td>4</td><td>0</td></tr> <tr><td>Switch Register</td><td>14</td><td>REV OFF</td><td>FWD OFF</td></tr> <tr><td>Key Switch</td><td>255</td><td>ACTIVE</td><td></td></tr> <tr><td>Speed Limit</td><td>254</td><td>0</td><td></td></tr> <tr><td>Hour Meter</td><td>1</td><td>INACTIVE</td><td></td></tr> </tbody> </table>	Function	Value	Reading	Minimum	Accelerator Volts	128	2.51	0.00	Motor Amps	128	0	-832	N/A	47	0	0	Battery Volts	66	24.88	0.00	T2 Volts	34	12.82	0.00	% On Time	255	-71	137	Thermal Protector	129	279	-25	% Battery Charge	70	70	0	F1 Current	6	-6.75	-7.65	F2 Current	191	21.00	-7.65	N/A	0	0		12 Volt Buss	55	4	0	Switch Register	14	REV OFF	FWD OFF	Key Switch	255	ACTIVE		Speed Limit	254	0		Hour Meter	1	INACTIVE	
Function	Value	Reading	Minimum																																																																			
Accelerator Volts	128	2.51	0.00																																																																			
Motor Amps	128	0	-832																																																																			
N/A	47	0	0																																																																			
Battery Volts	66	24.88	0.00																																																																			
T2 Volts	34	12.82	0.00																																																																			
% On Time	255	-71	137																																																																			
Thermal Protector	129	279	-25																																																																			
% Battery Charge	70	70	0																																																																			
F1 Current	6	-6.75	-7.65																																																																			
F2 Current	191	21.00	-7.65																																																																			
N/A	0	0																																																																				
12 Volt Buss	55	4	0																																																																			
Switch Register	14	REV OFF	FWD OFF																																																																			
Key Switch	255	ACTIVE																																																																				
Speed Limit	254	0																																																																				
Hour Meter	1	INACTIVE																																																																				

TRACTION STATUS CODE	DESCRIPTION OF STATUS	CAUSE OF STATUS INDICATION
-44	Armature transistor did not turn off properly.	This status code will be displayed when, during control operation, the armature transistor fails to turn off. This will result in a PMT condition
MEMORY RECALL YES	CORRECTIVE ACTIONS	<u>TROUBLE-SHOOTING DIAGRAM</u>
Circuits valid for Traction Controller	<p><u>SYMPTOM</u> Line contactor opens and closes, then can only be closed by opening and closing the key switch.</p> <p><u>POSSIBLE CAUSE</u> Defective control.</p> <ul style="list-style-type: none"> Replace controller unit. 	NO GRAPHIC FOR THIS STATUS CODE

TRACTION STATUS CODE	DESCRIPTION OF STATUS	CAUSE OF STATUS INDICATION
-45	Armature transistor did not turn on properly.	This status code will be displayed when, during control operation, the armature transistor fails to turn on properly. This will result in a PMT condition
MEMORY RECALL YES	CORRECTIVE ACTIONS	<u>TROUBLE-SHOOTING DIAGRAM</u>
Circuits valid for Traction Controller	<p><u>SYMPTOM</u> Control will not operate.</p> <p><u>POSSIBLE CAUSE</u> Defective control.</p> <ul style="list-style-type: none"> Replace controller unit. 	NO GRAPHIC FOR THIS STATUS CODE

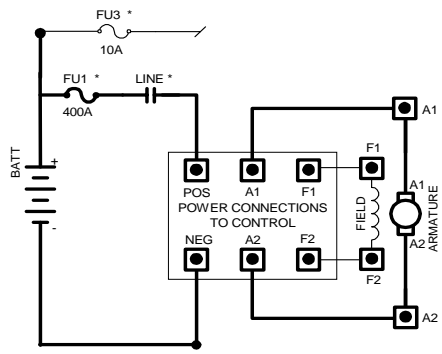
TRACTION STATUS CODE	DESCRIPTION OF STATUS	CAUSE OF STATUS INDICATION
-46	"Look Ahead" test for A2 volts is less than 12.5% of battery volts.	This status code will be displayed when the voltage at A2 is less than 12.5% of battery volts and I_m is greater than 52 amps, when the control is in the neutral state, with no start switch selected.
MEMORY RECALL YES	CORRECTIVE ACTIONS	<u>TROUBLE-SHOOTING DIAGRAM</u>
Circuits valid for Traction Controller	<p><u>SYMPTOM</u> Line contactor will not pickup.</p> <p><u>POSSIBLE CAUSE</u> Check for short circuit from the motor armature to the frame of the vehicle.</p> <p>Defective control.</p> <ul style="list-style-type: none"> Replace controller unit. 	 <p>The diagram shows a battery (BATT) connected to a control unit. The positive terminal of the battery goes through a 10A fuse (FU3) and a 400A fuse (FU1) to the LINE terminal of the control unit. The control unit has terminals POS, NEG, A1, A2, F1, and F2. The POS terminal is connected to the A1 terminal of the motor. The NEG terminal is connected to the A2 terminal of the motor. The F1 terminal is connected to the FIELD winding of the motor. The F2 terminal is connected to the ARMATURE of the motor. The motor is represented by a circle with a vertical line through it, with A1 at the top and A2 at the bottom.</p>

TRACTION STATUS CODE	DESCRIPTION OF STATUS	CAUSE OF STATUS INDICATION
-49	Motor field current is too low during the run mode.	This status code will be displayed when the current draw in the motor field is less than 1.3 amps and armature current is greater than 100 amps for more than 1.27 seconds during the run mode.
MEMORY RECALL YES	CORRECTIVE ACTIONS	<u>TROUBLE-SHOOTING DIAGRAM</u>
Circuits valid for Traction Controller	<p><u>SYMPTOM</u> Control will not operate.</p> <p><u>POSSIBLE CAUSE</u> Motor field is open circuit</p> <ul style="list-style-type: none"> • Replace motor <p>Loose between control and motor field</p> <ul style="list-style-type: none"> • Check connections <p>Defective control.</p> <ul style="list-style-type: none"> • Replace controller unit. 	NO GRAPHIC FOR THIS STATUS CODE

TRACTION STATUS CODE	DESCRIPTION OF STATUS	CAUSE OF STATUS INDICATION
-51	Capacitor volts are low before the line contactor closes.	This status code will be displayed during "key on" when the capacitor volts is less than 85% of battery volts at initial key switch on.
MEMORY RECALL NO	CORRECTIVE ACTIONS	<u>TROUBLE-SHOOTING DIAGRAM</u>
Circuits valid for Traction Controller	<p><u>SYMPTOM</u> Line contactor does not close when capacitor does not pre-charge.</p> <p><u>POSSIBLE CAUSE</u> Defective control fuse.</p> <ul style="list-style-type: none"> • Check control fuse for open circuit condition. Replace fuse, if necessary. • Turn key off and wait 1 minute, then try again. <p>Defective control.</p> <ul style="list-style-type: none"> • Replace controller unit. 	<p>The diagram shows a battery (BATT) connected to a control circuit. A 10A fuse (FU3) is in the line from the battery. A 400A fuse (FU1) is in the line to the motor. The control circuit includes a capacitor and a line contactor. The motor field and armature are connected to the control circuit. The field winding is connected to terminals F1 and F2. The armature is connected to terminals A1 and A2. The control circuit is connected to terminals POS and NEG.</p>

TRACTION STATUS CODE	DESCRIPTION OF STATUS	CAUSE OF STATUS INDICATION
-57	Controller "motor current sensor" input is too low during running.	This status code will be displayed when the voltage input from the current sensor is too low (less than 1.0V, 416 amps) during running.
MEMORY RECALL YES	CORRECTIVE ACTIONS	<u>TROUBLE-SHOOTING DIAGRAM</u>
Circuits valid for Traction Controller	<p><u>SYMPTOM</u> Control will not operate.</p> <p><u>POSSIBLE CAUSE</u> Line contactor tips bounce or are not fully picked up.</p> <p>Blown power fuse.</p> <p>Loose power connections between battery and control.</p> <p>Defective control.</p> <ul style="list-style-type: none"> Replace controller unit. 	NO GRAPHIC FOR THIS STATUS CODE

TRACTION STATUS CODE	DESCRIPTION OF STATUS	CAUSE OF STATUS INDICATION
-64	The line driver input (P2-17) is less than 12% of battery volts	This status code will be displayed when the control detects that the line driver input (P2-17) is less than 12% battery volts when the key switch is turned on.
MEMORY RECALL NO	CORRECTIVE ACTIONS	<u>TROUBLE-SHOOTING DIAGRAM</u>
Circuits valid for Traction Controller	<p><u>SYMPTOM</u> Control will not operate.</p> <p><u>POSSIBLE CAUSE</u> Open wire connection to Pin 17 on control</p> <p>Shorted line driver transistor</p> <p>Open line contactor coil</p> <p>Open connection between line contactor coil and battery positive.</p> <p>Defective control.</p>	<p>The diagram shows a connector with pins P1 through P17. P1 is connected to +72V. P17 is connected to a lamp (L) and +72V. P2 is connected to +72V. P21 is connected to MOTOR OVER TEMP. P6 is connected to TURF SW. P4 is connected to FORWARD SW. P5 is connected to REVERSE SW. P10 is connected to BUZZER. P12 is connected to 72V NEG. P3 is connected to BRAKE SW. P22 is connected to NEG INPUT START SW. P23 is connected to RS232. P9 is connected to ACC POT. P7 is connected to ACC POT. P8 is connected to ACC POT. P15, P14, and P16 are connected to RED, GREEN, and BLACK wires respectively, which are part of a TACHOMETER.</p>

TRACTION STATUS CODE	DESCRIPTION OF STATUS	CAUSE OF STATUS INDICATION
-65	The line coil current is too high during the run mode	This status code will be displayed when the current limit in the line coil is exceeded during the run mode. The line contactor will drop out and the key switch will have to be recycled to reset the control.
MEMORY RECALL YES	CORRECTIVE ACTIONS	<u>TROUBLE-SHOOTING DIAGRAM</u>
Circuits valid for Traction Controller	<p><u>SYMPTOM</u> Control will not operate.</p> <p><u>POSSIBLE CAUSE</u></p> <p>Shorted line contactor coil</p> <p>Short between wires connected to line coil (wires #10 and 24)</p> <p>Insure that all inductive loads are suppressed.</p> <p>Incorrect line contactor coil.</p> <p>Defective control.</p> <ul style="list-style-type: none"> Replace controller unit. 	

TRACTION STATUS CODE	DESCRIPTION OF STATUS	CAUSE OF STATUS INDICATION
-66	The field current exceeds the current limit of the field transistor.	This status code will be displayed when the field transistor exceeds its current limit. The line contactor will drop out and the key switch will have to be recycled to restart the control.
MEMORY RECALL YES	CORRECTIVE ACTIONS	<u>TROUBLE-SHOOTING DIAGRAM</u>
Circuits valid for Traction Controller	<p><u>SYMPTOM</u> Control will not operate or is sluggish on start up. Line contactor opens.</p> <p><u>POSSIBLE CAUSES</u></p> <ul style="list-style-type: none"> Shorted field F1 to F2 F1 or F2 terminals shorted to battery positive (B+) Confirm that all inductive loads/accessories are suppressed. Motor armature or field shorted to frame. <p>Defective control.</p> <ul style="list-style-type: none"> Replace controller unit. 	

TRACTION STATUS CODE	DESCRIPTION OF STATUS	CAUSE OF STATUS INDICATION
-76	Capacitor (1C) voltage too high during pedal up regen braking.	This status code will be displayed when the voltage at 1C exceeds 96 volts during the regenerative braking cycle.
MEMORY RECALL YES	CORRECTIVE ACTIONS	TROUBLE-SHOOTING DIAGRAM
Circuits valid for Traction Controller	<p>SYMPTOM Line contactor opens and closes, then opens and can only close by opening and closing the key switch.</p> <p>POSSIBLE CAUSE Batteries are overcharged.</p> <ul style="list-style-type: none"> • Regen current too high, cycle key switch off then on. <p>Defective control.</p> <ul style="list-style-type: none"> • Replace controller unit. 	

TRACTION STATUS CODE	DESCRIPTION OF STATUS	CAUSE OF STATUS INDICATION
-77	Capacitor (1C) voltage too high during motoring.	This status code will be displayed when the voltage at 1C exceeds 96 volts during motoring.
MEMORY RECALL YES	CORRECTIVE ACTIONS	TROUBLE-SHOOTING DIAGRAM
Circuits valid for Traction Controller	<p>SYMPTOM Line contactor opens and closes, then opens and can only close by opening and closing the key switch.</p> <p>POSSIBLE CAUSE Regen current too high, cycle key switch off then on.</p> <p>Defective control.</p> <ul style="list-style-type: none"> • Replace controller unit. 	

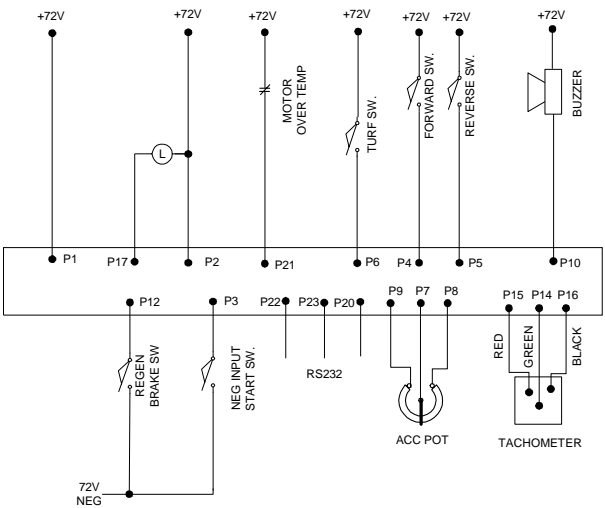
TRACTION STATUS CODE	DESCRIPTION OF STATUS	CAUSE OF STATUS INDICATION
-81	No tachometer signal is detected.	This status code will be displayed when no tachometer signal is detected.
MEMORY RECALL YES	CORRECTIVE ACTIONS	TROUBLE-SHOOTING DIAGRAM
Circuits valid for Traction Controller	<p>SYMPTOM Vehicle's speed will limited to about half of the normal speed.</p> <p>POSSIBLE CAUSE Defective tachometer.</p> <ul style="list-style-type: none"> • Replace tachometer unit <p>Defective wiring between tachometer and the control.</p> <ul style="list-style-type: none"> • Check and repair wiring as required. <p>Stalled motor</p> <ul style="list-style-type: none"> • Cycle key switch off then on. 	

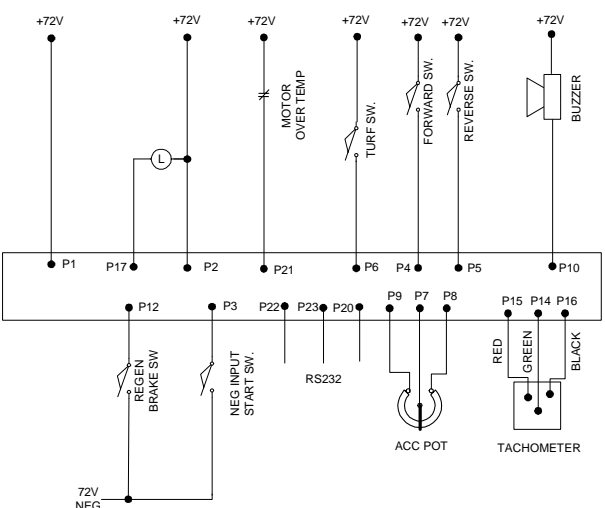
TRACTION STATUS CODE	DESCRIPTION OF STATUS	CAUSE OF STATUS INDICATION
-82	If the armature current greater than 280 amps for longer than 3.5 seconds in control mode, the armature motoring current will be turned off.	This status code will be displayed when the armature current exceeds 280 amps for 3.5 sec and the accelerator pedal is calling for maximum performance in the control mode.
MEMORY RECALL NO	CORRECTIVE ACTIONS	TROUBLE-SHOOTING DIAGRAM
Circuits valid for Traction Controller	<p>SYMPTOM The Control will not operate, and can only be reset by cycling the key switch.</p> <p>POSSIBLE CAUSE:</p> <ul style="list-style-type: none"> • Continued operation of vehicle in high motor current condition • Operating control at stall motor current for more than 3.5 seconds. • Defective motor tachometer • Function 16 is incorrectly adjusted for control % on time. <ul style="list-style-type: none"> - Adjust function per OEM instructions 	

Section 5: SETUP FUNCTIONS FOR TRACTION CONTROLLER

With *GE Digital Expertise for Palm OS™* or *GE Sentry for Windows*, the user can access any E² Prom setting, quickly perform various maintenance, diagnostic, and trouble-shooting tasks without the aid of additional test equipment. *GE Digital Expertise for Palm OS™* and *GE Sentry for Windows* links directly to the microprocessor in the controller. See *GE Digital Expertise for Palm OS™* and *GE Sentry for Windows instructions for additional details*.

Microsoft, Windows 95 and Windows NT are registered trademarks of Microsoft Corporation and Palm OS and HotSync are registered trademarks of Palm, Inc, the Palm logo and Palm Powered logo are the trademarks of Palm, Inc.

FUNCTION 1 MPH SCALING

This function allows for the pulses from the tachometer to be scaled to miles per hour, based on the number of pulses received by the control in a given time. For example, if you were scaling to 8 MPH, it would correspond to the length of time that it took to capture 8 tachometer pulses when the vehicle is traveling at 8 MPH. Note: This function should always be calculated using MPH.

Range	0 to 1.28 seconds
Set	0 to 255
Resolution	0.005 seconds per set unit
Example	Setting of 18 = 0.09 seconds

Example to determine sitting:

RR = Rolling Radius (Inches)
 Pi = 3.14159265
 GR = Gear Ratio
 PPR = Pulses per rotation of motor

$$\text{Setting} = \frac{3600 \times 2 \times \text{Pi} \times \text{RR}}{5280 \times 12 \times \text{GR} \times \text{PPR} \times .005}$$

$$\text{Setting} = \frac{3600 \times 2 \times 3.14159265 \times 9}{5280 \times 12 \times 8.91 \times 4 \times .005}$$

$$\text{Setting} = \frac{203575}{11290}$$

$$\text{Setting} = 18$$

FUNCTION 2 CREEP SPEED

This function allows for the adjustment of the creep speed of the vehicle when the accelerator potentiometer is at its minimum value and the start switch is closed.

Range	2% to 15% on time
Set	0 to 255
Resolution	0.047% per set unit
Example	Setting of 205 = (205x0.047)+2 = 11% on time

Important Note: The function is used to optimize motor and control performance and this setting will be determined by Flight Systems and OEM engineers at the time of vehicle development. This setting must not be changed by field personnel without the permission of the OEM.

FUNCTION 3 ARMATURE ACCELERATION RATE

This function allows for the adjustment of the rate of time it takes for the control to accelerate to 100% applied battery voltage to the motor on hard acceleration in the forward direction.

Range	0.1 to 25.5 seconds
Set	1 to 255
Resolution	0.086 seconds per set unit
Example:	Setting of 20 = 20 x 0.086=1.72 seconds

FUNCTION 4 MAX ARMATURE CURRENT LIMIT

This function allows for the adjustment of the armature current limit of the control during motoring.

Range	0 to 350 amps
Set	0 to 255
Resolution	1.38 amps per unit
Example:	Setting of 255 = (255x1.38) = 350 amps

FUNCTION 5 NOT USED

FUNCTION 6 ODOMETER CALIBRATION

This function is used to adjust the number of tachometer pulses (divided by 64) that are equivalent to 0.1 MPH.

Range	0 to 255
Set	0 to 255
Example:	RR = rolling radius GR = gear ratio PPR = pulses per rotation of motor

$$\text{Setting} = \frac{6336 \times \text{GR} \times \text{PPR}}{6.28 \times \text{RR} \times 64}$$

FUNCTION 7 MIN FIELD CURRENT

This function allows the adjustment of the field weakening level in order to set the top speed of the motor. **This function is used only when Mode 0 is selected.**

Range	0 to 20 amps
Set	51 to 195
Resolution	0.15 amps per set unit
Example	Setting of 73 = $(73-51) \times 0.15$ = 3.3 amps

CAUTION: Do not set this function to a value less than 51.

Important Note: The function is used to optimize motor and control performance and this setting will be determined by Flight Systems and OEM engineers at the time of vehicle development. This setting must not be changed by field personnel without the permission of the OEM.

FUNCTION 8 MAX FIELD CURRENT

This function allows for the adjustment of the maximum field current in order to obtain the maximum torque of the motor.

Range	0 to 30 amps
Set	51 to 255
Resolution	0.147 amps per set unit
Example	Setting of 251 = $(251-51) \times 0.147$ = 30 amps

CAUTION: Do not set this function to a value less than 51.

Important Note: The function is used to optimize motor and control performance and this setting will be determined by Flight Systems and OEM engineers at the time of vehicle development. This setting must not be changed by field personnel without the permission of the OEM.

FUNCTION 9 REGEN ARMATURE CURRENT LIMIT

This function allows for the adjustment of the maximum armature current limit during regenerative braking.

Range	32 to 350 amps
Set	1 to 255
Resolution	1.38 amps per set unit

Example Setting of 221 = (221×1.38)
 = 212 amps

FUNCTION 10 REGEN FIELD CURRENT LIMIT

This function allows for the adjustment of the maximum field current limit during regenerative braking.

Range	0 to 30 amps
Set	51 to 255
Resolution	0.147 amps per set unit
Example	Setting of 180 = $(180-51) \times 0.147$ = 19.0 amps

CAUTION: Do not set function 10 to a value less than 51.

Important Note: The function is used to optimize motor and control performance and this setting will be determined by Flight Systems and OEM engineers at the time of vehicle development. This setting must not be changed by field personnel without the permission of the OEM.

FUNCTION 11 TURF SPEED LIMIT

This function allows for the adjustment of the top speed of the vehicle (maximum battery volts to the motor) when it is in Turf Mode.

Range	100% to 0%
Set	0 to 255
Resolution	0.39% per set unit
Example:	Setting of 0 = no speed limit Setting of 255 = maximum speed reduction
Setting of 110	= $110/255 \times 100$ =43%

FUNCTION 12 REVERSE SPEED LIMIT

This function allows for the adjustment of the top speed of the vehicle (maximum battery volts to the motor) when it is being operated in the reverse direction.

Range	100% to 0%
Set	0 to 255
Resolution	0.39% per set unit
Example:	Setting of 0 = no speed limit Setting of 255 = maximum speed reduction
Setting of 110	= $110/255 \times 100$ =43%

FUNCTION 13 ROLLING RADIUS

This function allows for defining the vehicles rolling radius in inches.

Range 0 to 25.5 inches
 Set 0 to 255
 Resolution 0.1 inch per set unit
 Example Setting of 103 = 103 x 0.1
 = 10.3 inches

FUNCTION 14 INTERNAL RESISTANCE COMPENSATION

This function is used when the Battery Discharge Indicator is present. Adjustment of this function will improve the accuracy of the BDI. In order to determine this setting, the voltage drop of the battery under load must first be calculated by the following method:

1. Record open circuit voltage (Vo) by measuring the voltage at the control positive and negative power terminals.
2. Load the traction motor to 100 amps in 1A and record the voltage (VL) at the control positive and negative power terminals.
3. Calculate voltage drop (V_{Drop}) as follows:

$$V_{Drop} = V_O - V_L$$
4. Use the table below to determine the appropriate setting using the calculated V_{Drop} as a reference.

INTERNAL RESISTANCE COMPENSATION TABLE

Setting	V _{Drop}	Setting	V _{Drop}
2	11.44	17	1.34
3	7.60	18	1.27
4	5.72	19	1.20
5	4.57	20	1.14
6	3.81	21	1.09
7	3.27	22	1.04
8	2.86	23	0.99
9	2.54	24	0.95
10	2.28	25	0.91
11	2.08	26	0.88
12	1.90	27	0.85
13	1.76	28	0.82
14	1.63	29	0.79
15	1.52	30	0.76
16	1.43	31	0.74

FUNCTION 15 BATTERY VOLTS

This function allows for adjustment of voltage range for controllers with BDI function.

Battery Voltage	Setting Range
24V	Between 0 and 29
36V	Between 30 and 38
42V	Between 39 and 44
48V	Between 45 and 53

FUNCTION 16 GEAR RATIO

This function allows for defining the vehicles gear ratio in X to 1 format.

Range 0 to 25.5 units
 Set 0 to 255
 Resolution 0.1 per set unit
 Example Setting of 103 = 103 x 0.1
 = 10.3 to 1 gear ratio

FUNCTION 17 FIELD GAIN

This function allows for the adjustment of the pedal field gain. This value is determined by Flight Systems application engineering and should be set using the OEM setting specifications for this vehicle.

FUNCTION 18 FIELD OFFSET

This function allows for the adjustment of the pedal field offset. This value is determined by Flight Systems application engineering and should be set using the OEM setting specifications for this vehicle.

FUNCTION 19 PEDAL DOWN OR BRAKE REGEN RATE

This function adjusts the rate at which speed is reduced during regenerative when a direction change is made or the brake switch is closed in neutral.

Setting 1 to 255

Setting of 1 = Most aggressive braking
 Setting of 255 = Least aggressive braking

FUNCTION 20 PEDAL UP REGEN RATE

This function adjusts the rate at which speed is reduced during regenerative braking when the accelerator pedal is released.

Setting 1 to 255

Setting of 1 = Most aggressive braking
 Setting of 255 = Least aggressive braking

FUNCTION 21 TOP SPEED REGULATION POINT

This function adjusts the top speed regulation point of the vehicle.

Range 20 to 25.5 MPH
 Setting 200 to 255
 Resolution 0.1 MPH per set unit
 Example: Setting of 200 = 20.0 MPH
 Setting of 249 = 24.9 MPH

FUNCTION 22 NOT USED

Value should be set at zero.

**FUNCTION 23 ERROR COMPENSATION
(Push CONT 8)**

This function is used to reduce the ripple in field current due to the interaction between motor field design and the digital field current regulation circuit. The value for this function should be set to 0.

Important Note: The function is used to optimize motor and control performance and this setting will be determined by Flight Systems and OEM engineers at the time of vehicle development. This setting must not be changed by field personnel without the permission of the OEM.

FUNCTION 24 FIELD WEAKENING START (or MOTOR KNEE POINT)

This function allows for setting the armature current at which minimum field current will be achieved.

Range 0 to 255Amps
 Setting 0 to 255
 Resolution 1.0 per set unit
 Example: Setting of 26 = 26 amps.

Important Note: The function is used to optimize motor and control performance and this setting will be determined by Flight Systems and OEM engineers at the time of vehicle development. This setting must not be changed by field personnel without the permission of the OEM.

FUNCTION 25 NOT USED

Value should be set at zero.

FUNCTION 26 RATIO OF FIELD TO ARMATURE AMPS

This function sets the ratio between armature and field current when transitioning from minimum field to maximum field current. The setting represents the

quantity of field current changed for each 1 amp of armature current changed.

Max Change	Set	Resolution Per unit value	Example If set at 100
.18	0 to 255	0.00072 amps	0.072 amps

FUNCTION 27 HOUR METER MINUTES

This function adjusts the number of 30 second intervals registering in the hour meter. This function is typically not set by an OEM, it is usually only read from the register.

Range 0 to 60 minutes

 Resolution 0.5 minutes per set unit
 Setting 0 to 120
 Example Setting of 60 = 60 x 0.5 = 30 minutes

FUNCTION 28 STORED STATUS CODE COUNT POINTER

This register contains the location of the last stored status code recorded of the 16 stored status codes. These stored status codes have caused a PMT controller shutdown and/or disruption of normal vehicle operation.

FUNCTION 29 HOUR METER TENS AND UNITS HOURS SET

This function allows for the adjustment of the tens and units hours of the hour meter.

Range 0 to 99
 Set 0 to 99
 Example 9999 Hours

FUNCTION 30 HOUR METER THOUSANDS AND HUNDREDS HOURS SET

This function allows for the adjustment of the thousands and hundreds hours of the hour meter.

Range 0 to 99
 Set 0 to 99
 Example 9999 Hours

Section 6.0 MEMORY MAP

E²	Func No.	Traction Control Function	Access By	Restrictions
0	1	MPH Scaling	PC or PDA	None
1	2	Creep Speed	PC or PDA	None
2	3	Armature Acceleration Rate	PC or PDA	None
3	4	Max Armature Current Limit	PC or PDA	None
4	5	NOT USED	PC or PDA	None
5	6	Odometer Calibration	PC or PDA	None
6	7	Min Field Current	PC or PDA	None
7	8	Max Field Current	PC or PDA	None
8	9	Regen Armature Current Limit	PC or PDA	None
9	10	Regen Field Current Limit	PC or PDA	None
10	11	Turf Speed Limit	PC or PDA	None
11	12	Reverse Speed Limit	PC or PDA	None
12	13	Vehicle Tire Rolling Radius	PC or PDA	None
13	14	Internal Resistance Compensation	PC or PDA	None
14	15	Battery Volts Select	PC or PDA	None
15	16	Vehicle Gear Ratio	PC or PDA	None
16	17	Field Gain	PC or PDA	None
17	18	Field Offset	PC or PDA	None
18	19	Pedal Down or Brake Switch Regen Rate	PC or PDA	None
19	20	Pedal Up Regen Rate	PC or PDA	None
20	21	Top Speed Regulation Point	PC or PDA	None
21	22	NOT USED	PC or PDA	None
22	23	Error Compensation	PC or PDA	None
23	24	Field Weakening Start (or Motor Knee Point)	PC or PDA	None
24	25	NOT USED	PC or PDA	None
25	26	NOT USED	PC or PDA	None
26	27	Hour Meter Minutes	PC or PDA	None
27	28	Stored Status Code Count Pointer	PC or PDA	None
28	29	Hour Meter Tens and Units	PC or PDA	None
29	30	Hour Meter Thousands and Hundreds	PC or PDA	None
30	31	Aux HM (Tens/Ones)	PC or PDA	None
31	32	Aux HM (Thou/Hun)	PC or PDA	None
32	33	Stored Status Code #1	PC or PDA	Reset to Zero Only
33	34	BDI 1	PC or PDA	Reset to Zero Only
34	35	Hours (Tens/Ones) 1	PC or PDA	Reset to Zero Only
35	36	Hours (Thou/Hun) 1	PC or PDA	Reset to Zero Only
36	37	Stored Status Code #2	PC or PDA	Reset to Zero Only
37	38	BDI 2	PC or PDA	Reset to Zero Only
38	39	Hours (Tens/Ones) 2	PC or PDA	Reset to Zero Only
39	40	Hours (Thou/Hun) 2	PC or PDA	Reset to Zero Only
40	41	Stored Status Code #3	PC or PDA	Reset to Zero Only
41	42	BDI 3	PC or PDA	Reset to Zero Only
42	43	Hours (Tens/Ones) 3	PC or PDA	Reset to Zero Only
43	44	Hours (Thou/Hun) 2	PC or PDA	Reset to Zero Only
44	45	Stored Status Code #4	PC or PDA	Reset to Zero Only

E²	Func No.	Traction Control Function	Access By	Restrictions
45	46	BDI 4	PC or PDA	Reset to Zero Only
46	47	Hours (Tens/Ones) 4	PC or PDA	Reset to Zero Only
47	48	Hours (Thou/Hun) 4	PC or PDA	Reset to Zero Only
48	49	Stored Status Code #5	PC or PDA	Reset to Zero Only
49	50	BDI 5	PC or PDA	Reset to Zero Only
50	51	Hours (Tens/Ones) 5	PC or PDA	Reset to Zero Only
51	52	Hours (Thou/Hun) 5	PC or PDA	Reset to Zero Only
52	53	Stored Status Code #6	PC or PDA	Reset to Zero Only
53	54	BDI 6	PC or PDA	Reset to Zero Only
54	55	Hours(Tens/Ones) 6	PC or PDA	Reset to Zero Only
55	56	Hours(Thou/Hun) 6	PC or PDA	Reset to Zero Only
56	57	Stored Status Code #7	PC or PDA	Reset to Zero Only
57	58	BDI 7	PC or PDA	Reset to Zero Only
58	59	Hours(Tens/Ones) 7	PC or PDA	Reset to Zero Only
59	60	Hours(Thou/Hun) 7	PC or PDA	Reset to Zero Only
60	61	Stored Status Code #8	PC or PDA	Reset to Zero Only
61	62	BDI 8	PC or PDA	Reset to Zero Only
62	63	Hours(Tens/Ones) 8	PC or PDA	Reset to Zero Only
63	64	Hours(Thou/Hun) 8	PC or PDA	Reset to Zero Only
64	65	Stored Status Code #9	PC or PDA	Reset to Zero Only
65	66	BDI 9	PC or PDA	Reset to Zero Only
66	67	Hours(Tens/Ones) 9	PC or PDA	Reset to Zero Only
67	68	Hours(Thou/Hun) 9	PC or PDA	Reset to Zero Only
68	69	Stored Status Code #10	PC or PDA	Reset to Zero Only
69	70	BDI 10	PC or PDA	Reset to Zero Only
70	71	Hours(Tens/Ones) 10	PC or PDA	Reset to Zero Only
71	72	Hours(Thou/Hun) 10	PC or PDA	Reset to Zero Only
72	73	Stored Status Code #11	PC or PDA	Reset to Zero Only
73	; 74	BDI 11	PC or PDA	Reset to Zero Only
74	75	Hours(Tens/Ones) 11	PC or PDA	Reset to Zero Only
75	76	Hours(Thou/Hun) 11	PC or PDA	Reset to Zero Only
76	77	Stored Status Code #12	PC or PDA	Reset to Zero Only
77	78	BDI 12	PC or PDA	Reset to Zero Only
78	79	Hours(Tens/Ones) 12	PC or PDA	Reset to Zero Only
79	80	Hours(Thou/Hun) 12	PC or PDA	Reset to Zero Only
80	81	Stored Status Code #13	PC or PDA	Reset to Zero Only
81	82	BDI 13	PC or PDA	Reset to Zero Only
82	83	Hours(Tens/Ones) 13	PC or PDA	Reset to Zero Only
83	84	Hours(Thou/Hun) 13	PC or PDA	Reset to Zero Only
84	85	Stored Status Code # 14	PC or PDA	Reset to Zero Only
85	86	BDI 14	PC or PDA	Reset to Zero Only
86	87	Hours(Tens/Ones) 14	PC or PDA	Reset to Zero Only
87	88	Hours(Thou/Hun) 14	PC or PDA	Reset to Zero Only
88	89	Stored Status Code # 15	PC or PDA	Reset to Zero Only
89	90	BDI 15	PC or PDA	Reset to Zero Only
90	91	Hours (Tens/Ones) 15	PC or PDA	Reset to Zero Only
91	92	Hours (Thou/Hun) 15	PC or PDA	Reset to Zero Only

E ²	Func No.	Traction Control Function	Access By	Restrictions
92	93	Stored Status Code #16	PC or PDA	Reset to Zero Only
94	95	Hours (Tens/Ones) 16	PC or PDA	Reset to Zero Only
95	96	Hours (Thou/Hun) 16	PC or PDA	Reset to Zero Only
96	97	NOT USED	PC or PDA	None
97	98	NOT USED	PC or PDA	None
98	99	NOT USED	PC or PDA	None
99	100	NOT USED	PC or PDA	None
100	101	Not applicable	PC or PDA	None
101	102	Not applicable	PC or PDA	None
102	103	Not applicable	PC or PDA	None
103	104	Not applicable	PC or PDA	None
104	105	Not applicable	PC or PDA	None
105	106	Not applicable	PC or PDA	None
106	107	Not applicable	PC or PDA	None
107	108	Not applicable	PC or PDA	None
108	109	Not applicable	PC or PDA	None
109	110	Not applicable	PC or PDA	None
110	111	Not applicable	PC or PDA	None
111	112	Not applicable	PC or PDA	None
112	113	Secure HM (Tens/Ones)	PC or PDA	OEM Read Only
113	114	Secure HM (Thou/Hun)	PC or PDA	OEM Read Only
114	115	Secure Aux HM (Tens/Ones)	PC or PDA	OEM Read Only
115	116	Secure Aux HM (Thou/Hun)	PC or PDA	OEM Read Only
116	117	Field Offset	PC or PDA	OEM Read Only
117	118	Field Offset	PC or PDA	OEM Read Only
118	119	Armature Offset	PC or PDA	OEM Read Only
119	120	Reserved	PC or PDA	GE Future Use
120	121	OEM Use	PC or PDA	None
121	122	OEM Use	PC or PDA	None
122	123	OEM Use	PC or PDA	None
123	124	OEM Use	PC or PDA	None
124	125	Mile 1	PC or PDA	None
125	126	Mile 100	PC or PDA	None
126	127	Mile 1A	PC or PDA	None
127	128	Mile 6	PC or PDA	None

Numbers in (***bold italics***) are Stored Status Code pointers.